

T

T-Series

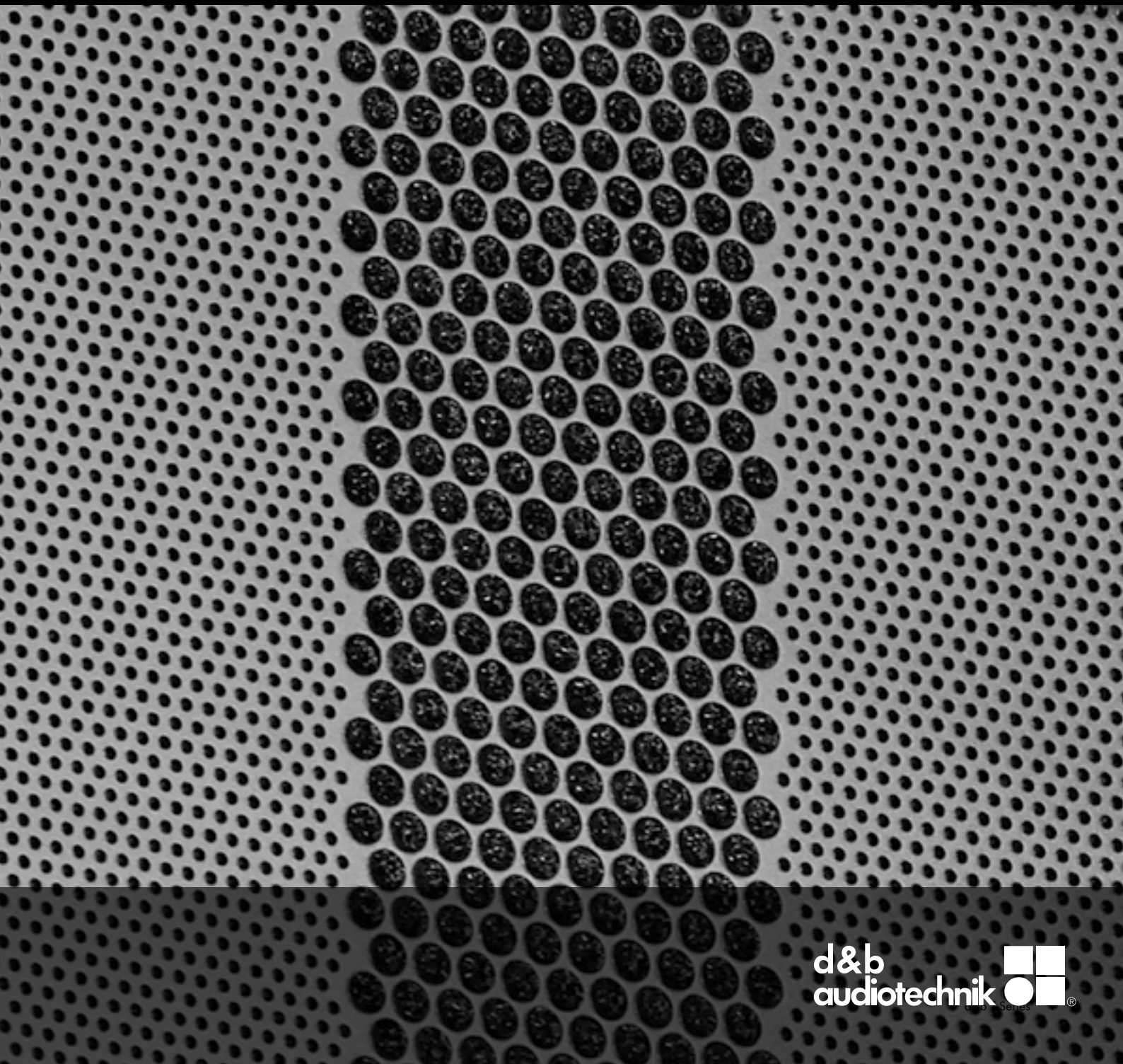

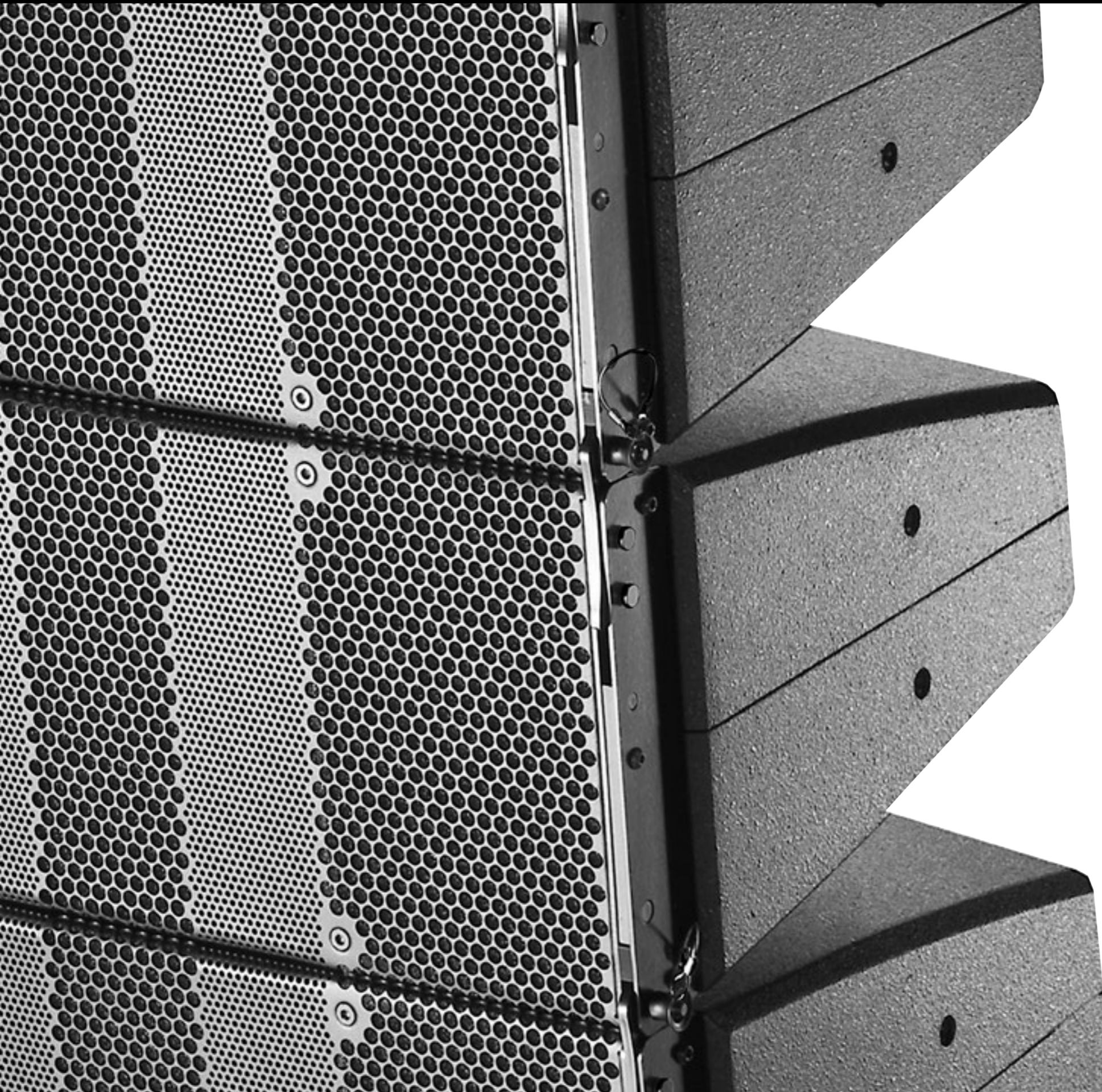

The d&b System reality	4
The T-Series	6
The T10 loudspeaker	10
The T10 electroacoustic concept	11
The Ti10L loudspeaker	12
The Ti10P loudspeaker	13
The T and Ti subwoofers	14
The B4 subwoofer	15
The T-Series rigging and mounting accessories	16
The T-Series rigging and mounting examples	17
The Ti Weather Resistant, Special Colour and Custom solutions options	18
The T-Series cases	19
The d&b ArrayCalc simulation software	20
The d&b NoizCalc immission modelling software	22
The d&b R1 Remote control software	23
The d&b amplifiers	24
The controller setups and operation with d&b amplifiers	26
The T-Series frequency responses	27
The d&b amplifier output modes	28
The DS10 and DS20 Audio network bridges	29
The DS100 Signal Engine	29
The T-Series configuration examples	30
The T-Series cables and adapters	34
The T-Series product overview	38

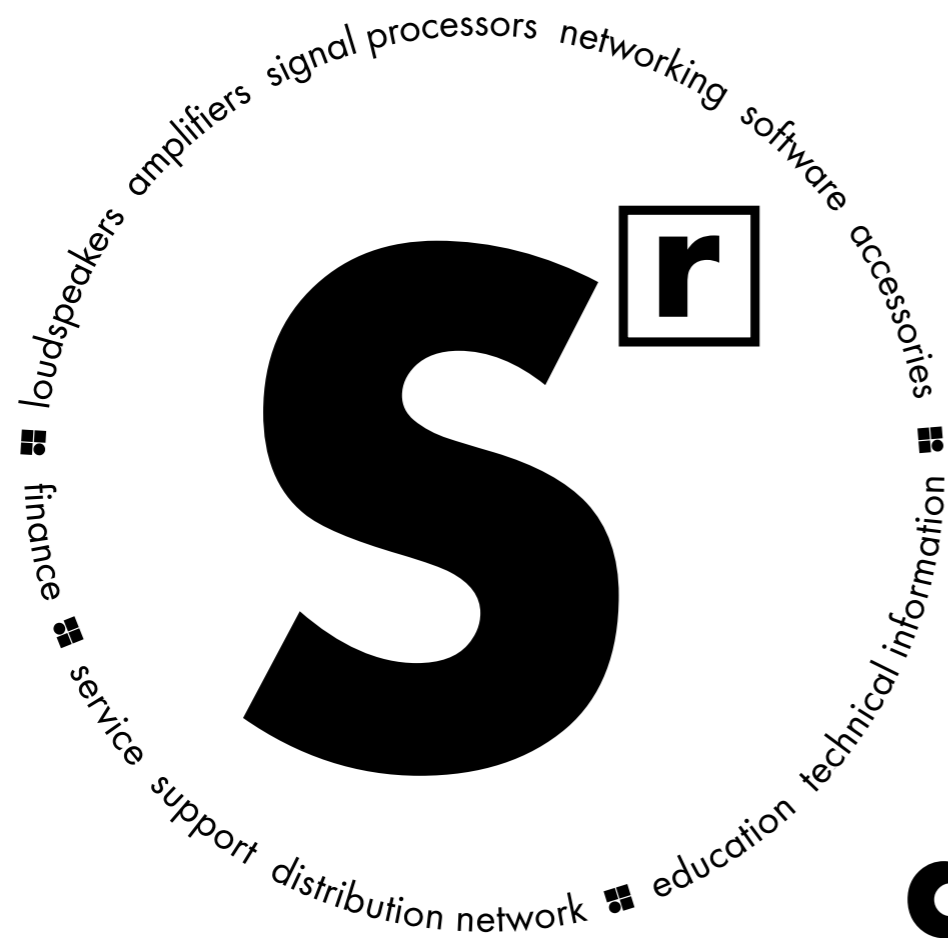

d&b System reality

As the name implies a d&b audiotechnik system is not just a loudspeaker. Nor is it merely a sum of the components: loudspeakers, amplifiers, signal processors, networking, software and accessories. Right from the outset the d&b audiotechnik approach was to build integrated sound reinforcement systems

that actually are more than the combination of parts: an entirety where each fits all. Every element is tightly specified, precisely aligned and carefully matched to achieve maximum efficiency. For ease of use, all the user-definable parameters are incorporated, allowing the possibility of adjustment, either

directly, via remote control surfaces, or integrated within wider networks. Neutral sound characteristics leave the user all the freedom needed to realize whatever the brief. At the same time d&b offers finance, service and support, a knowledgeable distribution network, education and training as well as technical

information, so the same optimal acoustic result is achieved consistently by every system anywhere, at any time. In reality: the d&b System reality.

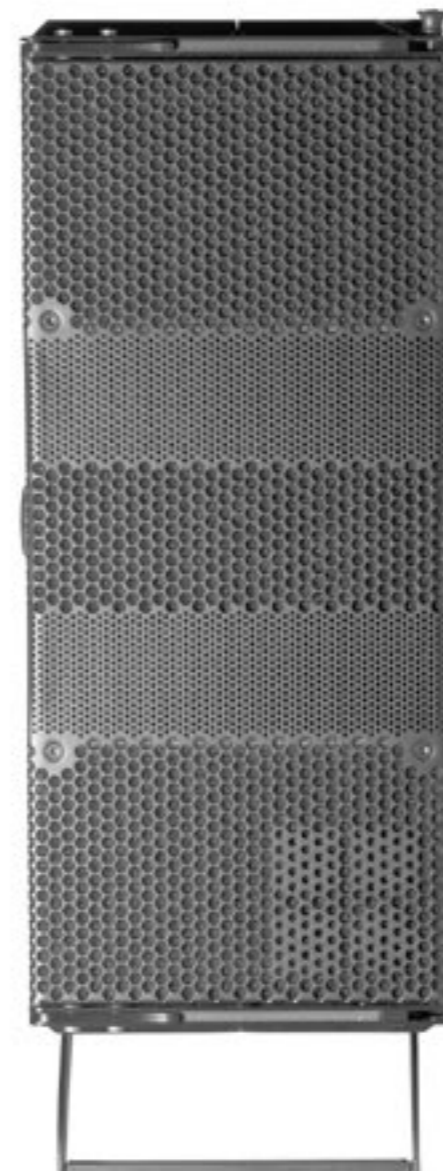

The **T-Series** offers two different loudspeaker technologies in one package delivering considerable performance as the smallest d&b line array and with a twist transforming into a stand-alone point source system. A fusion of techniques is used to deliver exemplary directivity control for situations where gain before feedback is an absolute requirement. These encompass

dipolar low frequency driver arrangements, high excursion drivers and a unique combination of rotatable horn and acoustic lens. The broad application scope of the T-Series ranges from small to medium sized applications. The unobtrusive visual design, compact dimensions, high power and exemplary directivity performance makes the T-Series loudspeakers a good choice in

many theatres, musicals, conference and presentation situations, live television and orchestral shows. The **T Loudspeakers** integrate specially designed unobtrusive rigging and mounting allowing quick and simple deployment in changing environments with the clear perspective to provide mobile, flexible, configurable sound solutions. The **Ti loudspeakers** differ only in cabinet

construction and mounting hardware. They are intended for permanently installed performance spaces where the specification is rider driven by the artist or mix engineer's preferences. The Ti cabinets and mounting hardware are mechanically adapted for installation use, are weather protected for climatically hostile environments and can be colour matched to interior designs.

The T-Series

The 2-way passive **T10** may be deployed in multiples as line array that maintains horizontal constant directivity down to approximately 600 Hz or as a high directivity point source loudspeaker. Accurate control of horizontal directivity is further enhanced by a large frequency overlap through the crossover range, while adaption for line source or point source orientation is achieved without the use of any tools. The T10 HF driver is fitted to a waveguide horn producing vertical line source directivity. Rotation of the horn by 90° produces an accurate point source dispersion transforming a vertically oriented T10 into a stand-alone full range loudspeaker. When the T10 is deployed upright as a point source, the vertical directivity control extends approximately one octave lower than similarly sized biaxial loudspeakers.

The installation specific **Ti10L** and **Ti10P** share the same characteristics, with different versions designed for varied applications: the Ti10L loudspeaker is used in multiples as elements of line arrays and incorporates appropriate rigging, whilst the Ti10P is used as a point source standalone loudspeaker without the line array hardware.

The **T** and **Ti** are actively driven bass-reflex subwoofers utilizing a long excursion 15" neodymium driver, sharing the same width and integrated rigging fittings as the T10 and Ti10L respectively. They are used to increase the low frequency headroom and extend the bandwidth of a T10 and Ti10L column down to 47 Hz.

The **B4** is intended for use in mobile applications. It's a compact high performance cardioid subwoofer utilizing two long excursion neodymium drivers in an integrated cardioid setup to avoid unwanted energy behind the system. This passive cardioid design is driven by a single amplifier channel and intended for ground stacked setups

All T loudspeakers are finished with a PCP (Polyurea Cabinet Protection) coating that provides mobile systems with protection against impact and resistance to the adverse effects on cabinets caused by changing ambient outdoor conditions.

The d&b software offering aides the entire system setup process. The d&b **ArrayCalc** simulation software allows the virtual optimization of loudspeaker line arrays, point source and column loudspeakers as well as subwoofers and their adjustment to venue conditions. The d&b **NoizCalc** immission modelling software uses international standards to model noise immission from d&b loudspeaker systems. NoizCalc takes data from

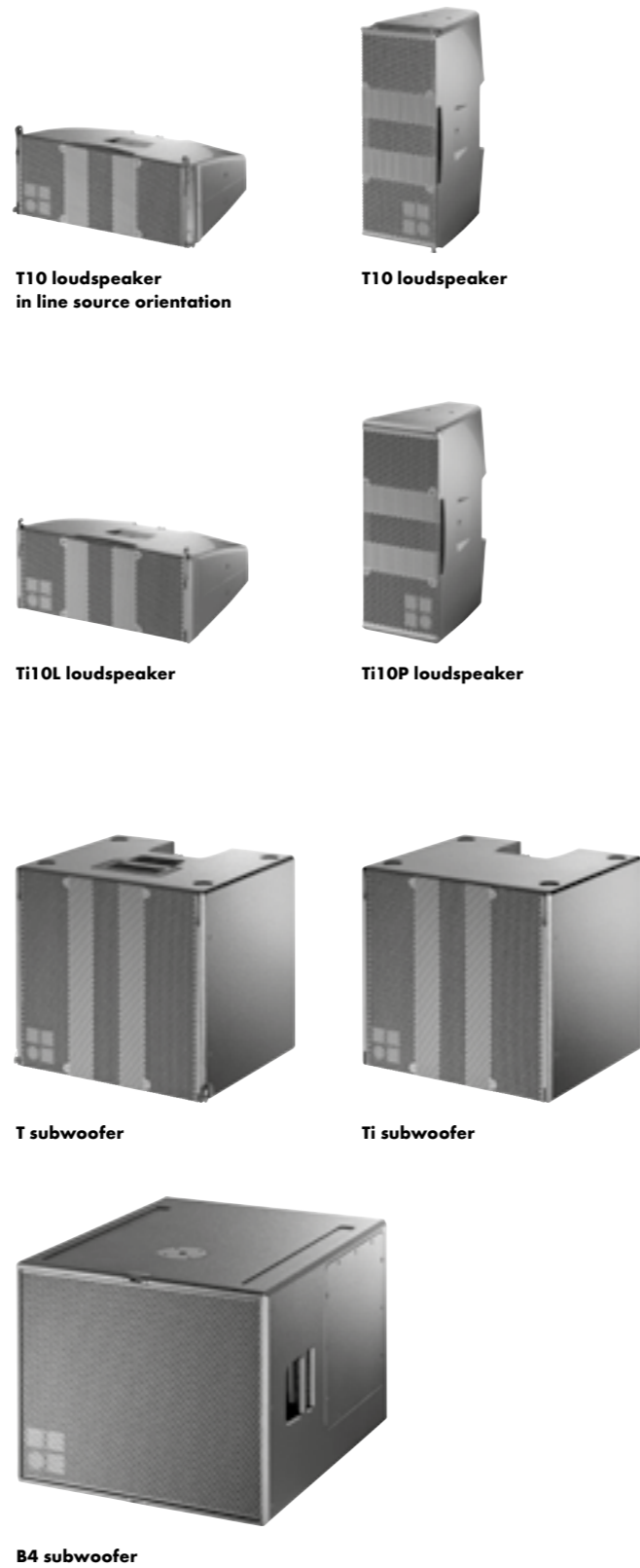

ArrayCalc and calculates the sound propagation towards the far field. The complete system configuration simulated in ArrayCalc is assimilated by the d&b **R1** Remote control software into an intuitive graphical user interface to manage the amplifiers, and loudspeakers, from anywhere in the venue. The **R90** Touchscreen remote control provides quick, reliable, and effortless operation of day-to-day functions of a preconfigured d&b system, without needing expert level knowledge of audio.

A wide range of tools and data files are available to support the planning process using external tools. For enhanced acoustic simulations, all loudspeakers offer EASE files. The planning process using BIM (Building Information Modelling) is supported with Revit files available for all loudspeakers and accessories, creating accurate project data and visualisation. Additionally, our 2D and 3D CAD data is usable in most common planning tools. Venue data created by SketchUp can be imported to ArrayCalc using the d&b sketchup plug-in to facilitate system design.

d&b amplifiers are specifically designed for use with d&b loudspeakers, and are at the heart of the d&b system approach. These devices contain extensive Digital Signal Processing capabilities to provide comprehensive loudspeaker management and specific switchable filter functions to precisely target the system response for a wide variety of applications. The four channel **D20** and **D40** amplifiers are intended for mobile applications requiring medium to high Sound Pressure Levels. The installation specific four channel **5D**, **30D** and **40D** amplifiers are intended for permanent integration within venues. These amplifiers all provide extensive user-definable equalization containing equalizers with parametric, notch, shelving and asymmetric filters as well as delay capabilities of up to 10 seconds.

The d&b Audio network bridges interface between audio transport networks and AES3 digital audio signals while also providing distribution of Ethernet control data. The **DS10** supports Dante networks, while the **DS20** is used for the open standards-based Milan protocol.

The **DS100** Signal Engine is based on a specialized rack mount 3 RU audio processor with Audinate Dante networking. It provides a 64 x 64 audio matrix with level and delay adjustments at all cross points. Additional software modules provide dynamic source positioning and emulated acoustics functions.

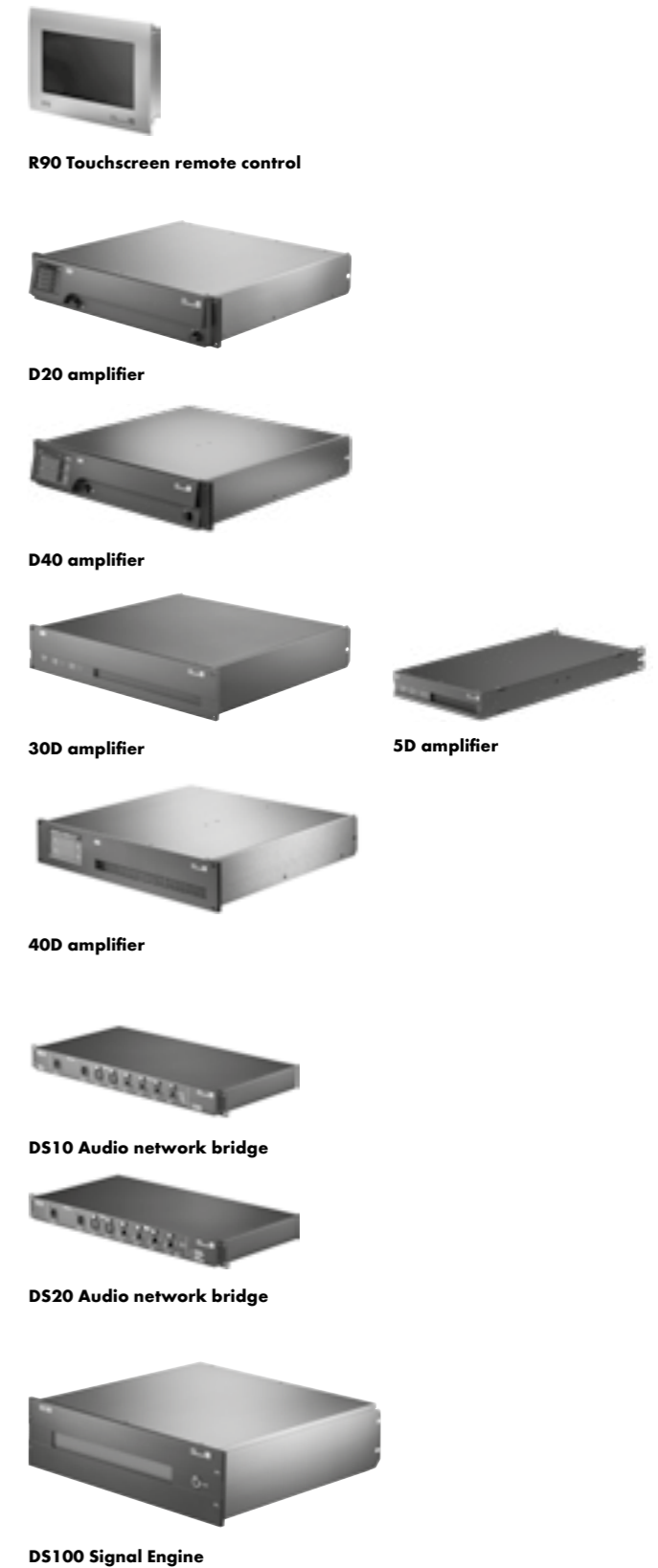

The T10 loudspeaker

The T10 electroacoustic concept

T10 loudspeaker

The T10 cabinet is a passive 2-way design that houses 2 x 6.5" drivers, a 1.4" exit HF compression driver and can be either used as a line source or high directivity point source loudspeaker. The very compact loudspeaker design is a unique combination of a rotatable waveguide with horn and an acoustic lens. The horn can easily be rotated from outside the loudspeaker without tools or removing the front grill. This is achieved through apertures at the cabinet sides which allow rotation to both the line and point source positions. The T10 provides a vertical line source with a 90° horizontal dispersion that is maintained down to approximately 600 Hz, whilst the integrated lens in the front grill widens the HF dispersion in line array mode to 105°. When the loudspeaker is used upright as a point source, the lens curves the wave front of the line source providing a 90° x 35° dispersion pattern. The two 6.5" neodymium LF drivers are positioned in a dipolar arrangement providing an exceptional dispersion control even at lower frequencies.

The T10 cabinet is constructed from polyurethane integral hard foam with an impact resistant finish and has integrated line array rigging hardware. The front of the loudspeaker cabinet is protected by a rigid metal grill backed by an acoustically transparent foam.

System data line source • point source

Frequency response (-5 dB standard) 68 Hz - 18 kHz
 Frequency response (-5 dB CUT mode)..... 120 Hz - 18 kHz
 Max. sound pressure (Line/Arc setup • PS setup, 1 m, free field)¹
 with 10D 129 • 127 dB
 with D20/D40/D80 132 • 130 dB
 with 5D/30D/40D..... 132 • 130 dB

Loudspeaker data

Nominal impedance 16 ohms
 Power handling capacity (RMS/peak 10 msec) 200/800 W
 Nominal dispersion angle (line source, horizontal)..... 105°
 Nominal dispersion angle (point source, h x v)..... 90° x 35°
 Components 2 x 6.5" driver with neodymium magnet
 1.4" exit compression driver on rotatable waveguide
 passive crossover network
 Connections 2 x NLT4 F/M
 optional 2 x NL4
 Weight..... 11 kg (24 lb)

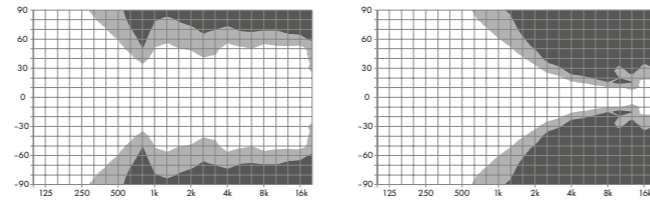

T10 horizontal dispersion characteristics, line source²

T10 vertical dispersion characteristics, line source²

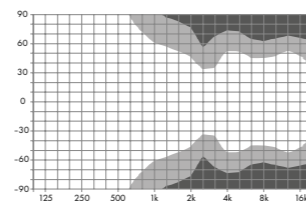

T10 horizontal dispersion characteristics, point source²

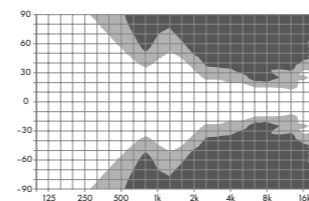

T10 vertical dispersion characteristics, point source²

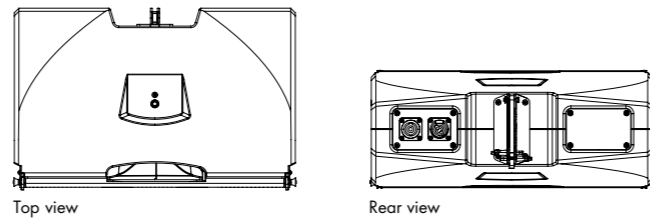
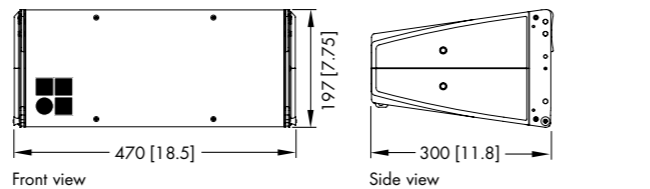

T10 cabinet dimensions in mm [inch]

The unique combination of a rotatable waveguide with horn and an acoustic lens enables T10 to transform from line source to point source mode easily from outside without tools or removing the front grill. This provides a vertical line source with a 90° horizontal dispersion, whilst the integrated lens in the front grill widens the HF dispersion in line source mode to 105°. When the loudspeaker is used upright as a point source, the lens curves the wave front of the line source providing a 90° x 35° dispersion pattern.

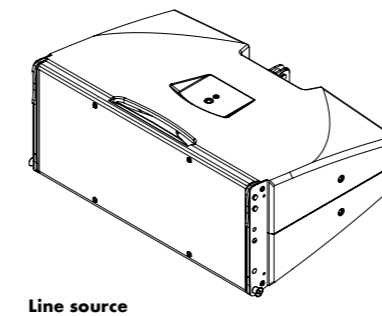

Line source

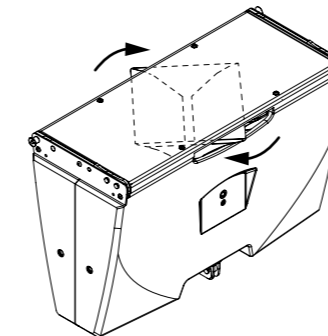

Rotating horn

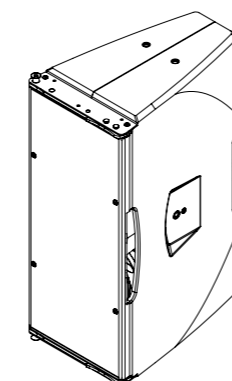

Point source

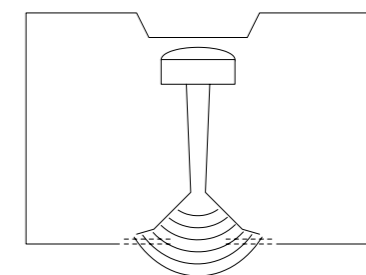
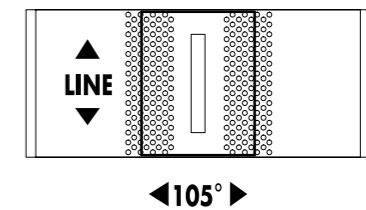

T10 horn and lens in line source setup

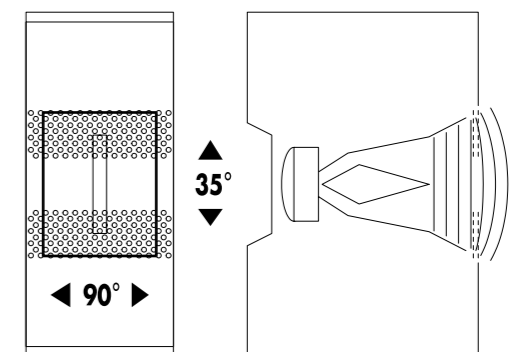

T10 horn and lens in point source setup

¹ Broadband measurement, pink noise, crest factor 4, peak measurement, linear weighting
² Dispersion angle vs frequency plotted using lines of equal sound pressure (isobars) at -6 dB and -12 dB

The Ti10L loudspeaker

Ti10L loudspeaker

The Ti10L loudspeaker is the installation version of the T10 for deployment as a line array loudspeaker. Road and installation versions differ only in the rigging hardware.

The Ti10L cabinet is a passive 2-way design that houses 2 x 6.5" drivers and a 1.4" exit HF compression driver. The very compact loudspeaker design is a unique combination of a rotatable waveguide with horn and an acoustic lens. It provides a vertical line source with a 90° horizontal dispersion that is maintained down to approximately 600 Hz, whilst the integrated lens in the front grill widens the HF dispersion in line array mode to 105°. The two 6.5" neodymium LF drivers are positioned in a dipolar arrangement providing an exceptional directivity control even at lower frequencies.

The Ti10L cabinet is constructed from polyurethane integral hard foam with an impact resistant finish and has integrated line array rigging hardware which, once deployed is fundamentally invisible when viewed from the front. The front of the loudspeaker cabinet is protected by a rigid metal grill backed by an acoustically transparent foam.

System data

Frequency response (-5 dB standard)	68 Hz - 18 kHz
Frequency response (-5 dB CUT mode)	120 Hz - 18 kHz
Max. sound pressure (1 m, free field) ¹	
with 10D	129 dB
with D20/D40/D80	132 dB
with 5D/30D/40D	132 dB

Loudspeaker data

Nominal impedance	16 ohms
Power handling capacity (RMS/peak 10 msec)	200/800 W
Nominal dispersion angle (h)	105°
Components	2 x 6.5" driver with neodymium magnet
	1.4" exit compression driver on rotatable waveguide
	passive crossover network
Connections	2 x NL4
Weight	11 kg (24 lb)

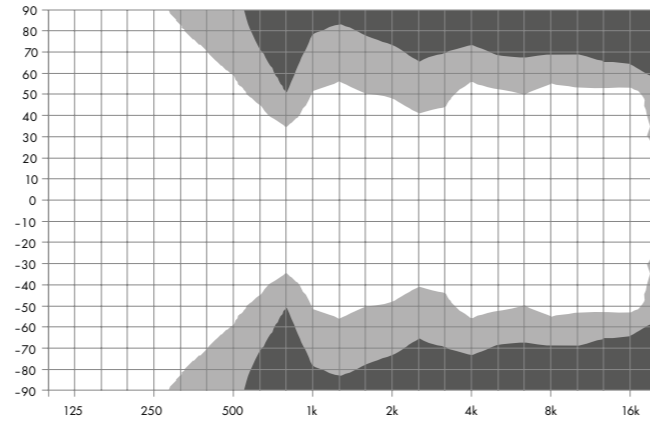

Ti10L horizontal dispersion characteristics²

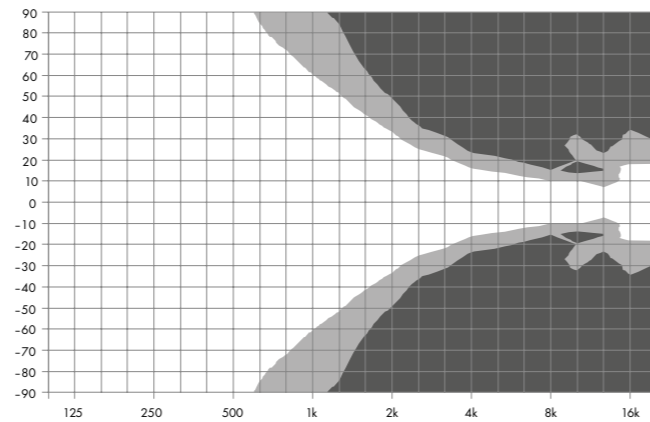

Ti10L vertical dispersion characteristics²

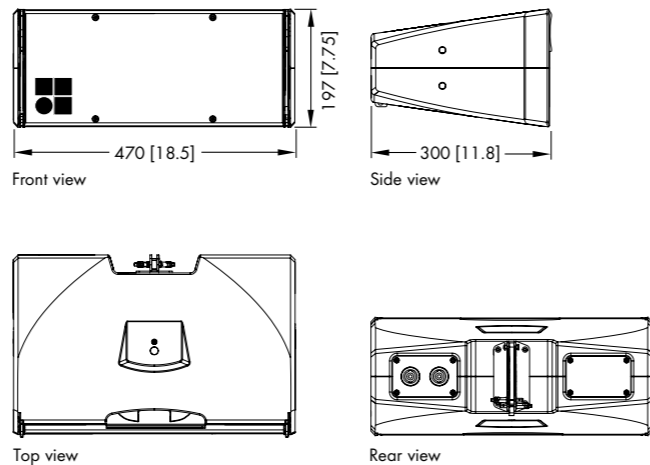

Ti10L cabinet dimensions in mm [inch]

¹ Broadband measurement, pink noise, crest factor 4, peak measurement, linear weighting
² Dispersion angle vs frequency plotted using lines of equal sound pressure (isobars) at -6 dB and -12 dB

The Ti10P loudspeaker

Ti10P loudspeaker

The Ti10P loudspeaker is the installation version of the T10 for deployment as a point source loudspeaker. Road and installation versions differ only in the mounting hardware.

The Ti10P cabinet is a passive 2-way design that houses 2 x 6.5" drivers, a 1.4" exit HF compression driver and can be used either in horizontal or vertical orientation. The very compact loudspeaker design is a unique combination of a rotatable waveguide with horn and an acoustic lens. The horn can easily be rotated from outside the loudspeaker without tools or removing the front grill. This is achieved through apertures at the cabinet sides which allow rotation to both vertical or horizontal setup. It provides a vertical line source with a 90° horizontal dispersion that is maintained down to approximately 600 Hz, whilst the integrated lens in the front grill widens the HF dispersion in horizontal setup to 105°. When the loudspeaker is used upright, the lens curves the wave front of the line source providing a 90° x 35° dispersion pattern. The two 6.5" neodymium LF drivers are positioned in a dipolar arrangement providing exceptional directivity control even at lower frequencies.

The Ti10P cabinet is constructed from polyurethane integral hard foam with an impact resistant finish and has integrated threads for attaching installation hardware. The front of the loudspeaker cabinet is protected by a rigid metal grill backed by an acoustically transparent foam.

System data

Frequency response (-5 dB standard)	68 Hz - 18 kHz
Frequency response (-5 dB CUT mode)	120 Hz - 18 kHz
Max. sound pressure (1 m, free field) ¹	
with 10D	127 dB
with D20/D40/D80	130 dB
with 5D/30D/40D	130 dB

Loudspeaker data

Nominal impedance	16 ohms
Power handling capacity (RMS/peak 10 msec)	200/800 W
Nominal dispersion angle (h x v)	90° x 35°
Components	2 x 6.5" driver with neodymium magnet
	1.4" exit compression driver on rotatable waveguide
	passive crossover network
Connections	2 x NL4
Weight	10 kg (23 lb)

¹ Broadband measurement, pink noise, crest factor 4, peak measurement, linear weighting
² Dispersion angle vs frequency plotted using lines of equal sound pressure (isobars) at -6 dB and -12 dB

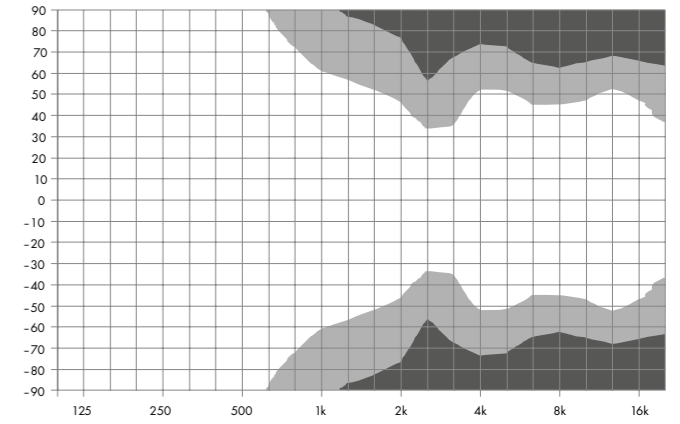

Ti10P horizontal dispersion characteristics²

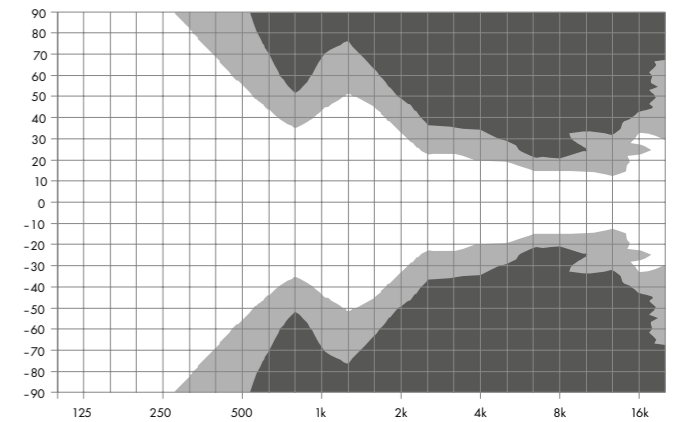

Ti10P vertical dispersion characteristics²

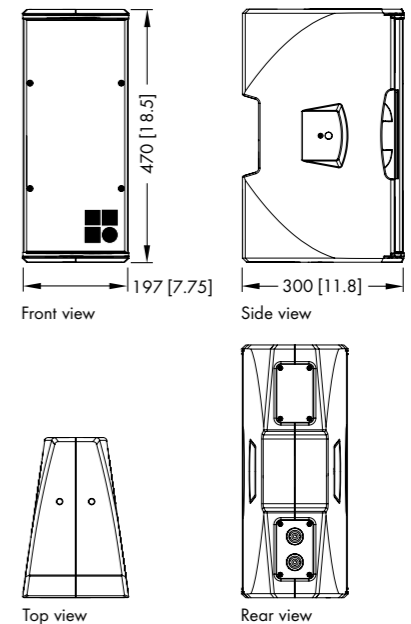

Ti10P cabinet dimensions in mm [inch]

The T and Ti subwoofers

T and Ti subwoofers

The T and Ti-SUB are actively driven bass-reflex designs housing a long excursion 15" driver with a neodymium magnet. They can be used to supplement the LF headroom of the T and Ti loudspeakers in various combinations, ground stacked or flown, either integrated on top of an array or as a separate column. They can also supplement the T10 and Ti10 loudspeakers respectively in ground stacked applications where the SUBs can mechanically support them.

The cabinets are mechanically connected using rigging links on both sides of the cabinet front which slide out when needed, and with a central splay link at the rear of the cabinet. All necessary rigging components are mounted to the cabinet. The T and Ti-SUB cabinets are constructed from marine plywood and have an impact resistant paint finish. The T-SUB cabinet has a handle mounted in the top panel. The front of the loudspeaker cabinets are protected by a rigid metal grill in front of an acoustically transparent foam.

System data

Frequency response (-5 dB standard)47 - 140 Hz
 Frequency response (-5 dB 100 Hz mode).....47 - 100 Hz
 Max. sound pressure (single cabinet, 1 m, free field)¹
 with 10D 127 dB
 with D20/30D/40D 130 dB
 with D40/D80..... 130 dB

Loudspeaker data

Nominal impedance8 ohms
 Power handling capacity (RMS/peak 10 msec)300/1600 W
 Components 15" driver with neodymium magnet
 Connections T-SUB2 x NLT4 F/M
 optional 2 x NL4
 Connections Ti-SUB2 x NL4
 Weight..... 17 kg (37 lb)

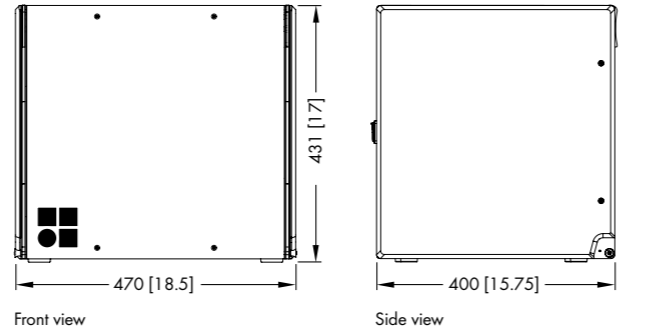

Front view

Side view

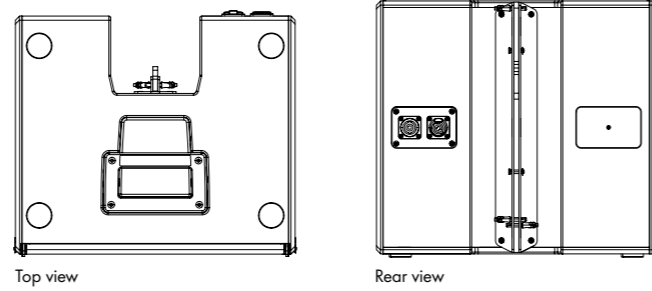

Top view

Rear view

T-SUB cabinet dimensions in mm [inch]

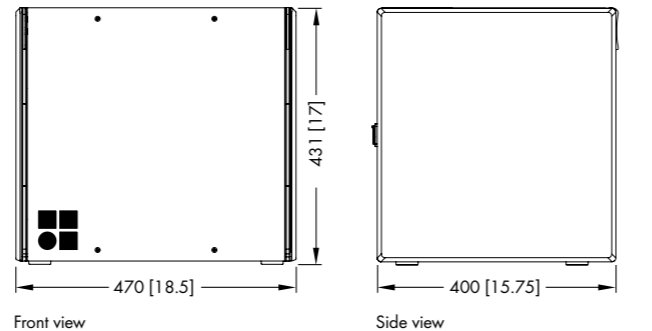

Front view

Side view

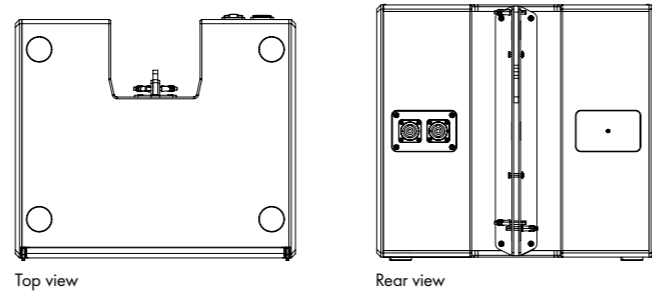

Top view

Rear view

Ti-SUB cabinet dimensions in mm [inch]

The B4 subwoofer

B4 subwoofer

The B4-SUB is an actively driven cardioid subwoofer powered by a single amplifier channel. It houses two long excursion neodymium drivers in an integrated cardioid setup: a 15" driver in a bass-reflex design facing to the front and a 12" driver in a two chamber bandpass design radiating to the rear. The cardioid dispersion pattern resulting from this arrangement unwanted energy behind the system that greatly reduces the excitation of the reverberant field at low frequencies and provides the greatest accuracy of low frequency reproduction. The B4 subwoofer can only be used in a ground stacked configuration. The B4-SUB cabinet is constructed from marine plywood and has an impact and weather resistant paint finish and a pair of handles. An M20 threaded flange in the top panel accepts the d&b Loudspeaker stand winder M20. The front of the loudspeaker cabinet is protected by a rigid metal grill backed by an acoustically transparent foam. Two runners extend from the rear to the front panel of the cabinet protecting the bottom panel against scratching. Two correspondingly shaped recesses are incorporated in the top panel of each cabinet that accept these runners to prevent cabinet movement when stacked.

System data

Frequency response (-5 dB standard)40 - 150 Hz
 Frequency response (-5 dB 100 Hz mode).....40 - 100 Hz
 Max. sound pressure (1 m, free field)¹
 with 10D 128 dB
 with D20/30D/40D 131 dB
 with D40/D80..... 131 dB

Loudspeaker data

Nominal impedance6 ohms
 Power handling capacity (RMS/peak 10 msec)500/2000 W
 Components
 Front/Rear 15"/12" driver
 Connections2 x NLT4 F/M
 optional 2 x NL4
 Weight..... 44 kg (97 lb)

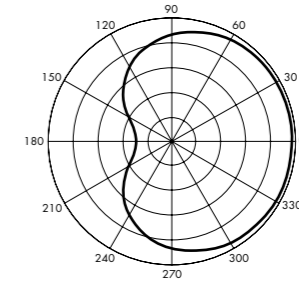

Cardioid polar pattern

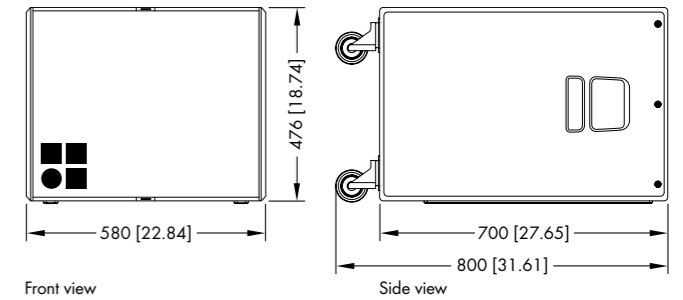

Front view

Side view

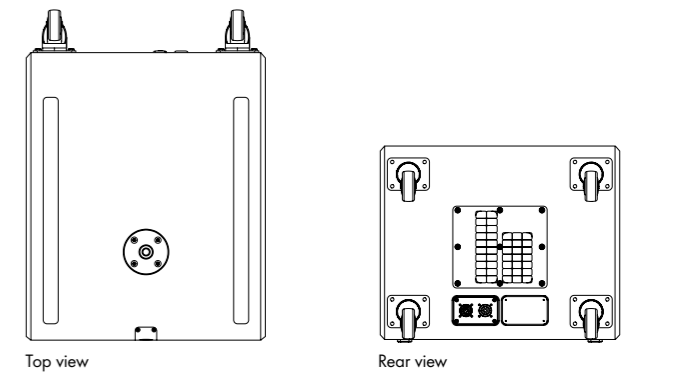

Top view

Rear view

B4-SUB cabinet dimensions in mm [inch]

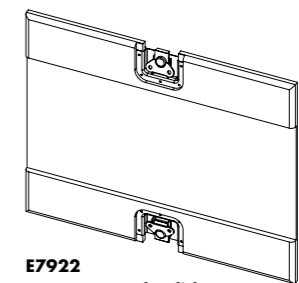

E7922
B4-SUB Wooden lid

The T-Series rigging and mounting accessories

The T-Series rigging and mounting examples

Safety approval

d&b loudspeakers and accessories are designed for setup and use within situations requiring compliance with the provisions and directives of the DGUV regulation 17 (formerly BGV C1).

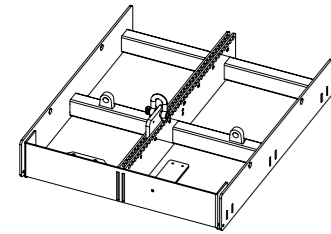

Z5370
T Flying frame
2 x Z5160 Q Load adapter supplied with each T Flying frame

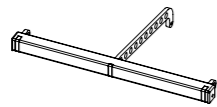

Z5374
Ti Flying bar

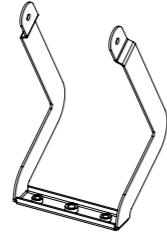

Z5371
T Flying bracket

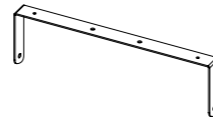

Z5372
T Horizontal bracket

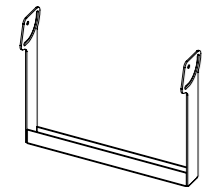

Z5373
T Cluster bracket
for up to 3 x T10/Ti10L

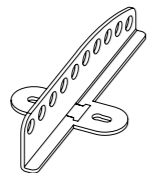

Z5354
E8/E12 Flying adapter



Z5355
E8/E12 Flying adapter link

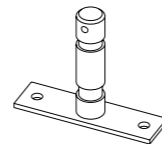

Z5010
TV Spigot with fixing plate

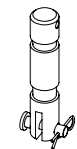

Z5015
TV Spigot for Flying adapter 02

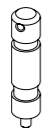

Z5029
TV Spigot M10

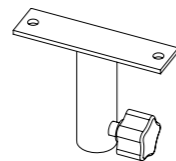

Z5024
Loudspeaker stand adapter

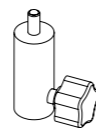

Z5034
Stand adapter M10

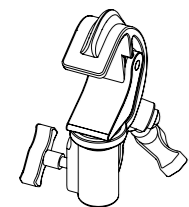

Z5012
Pipe clamp for TV Spigot
For a tube diameter up to 70 mm/2.75"

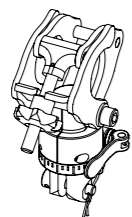

Z5147
Rota clamp
WLL: 500 kg (1100 lb)
for a tube diameter up to 51 mm/2"



Z5155
T/Q Hoist connector chain



E6507
1t Shackle

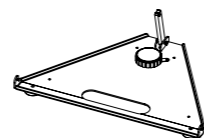

Z5375
T Base plate
for T10 with B4 and Q-SUB only

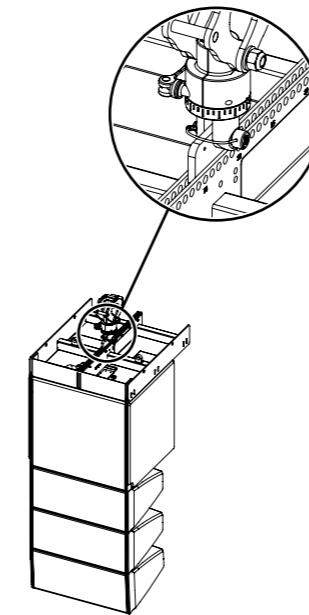

T10/T-SUB or Ti10L/Ti-SUB
line array with
Z5370 T Flying frame
Z5147 Rota clamp

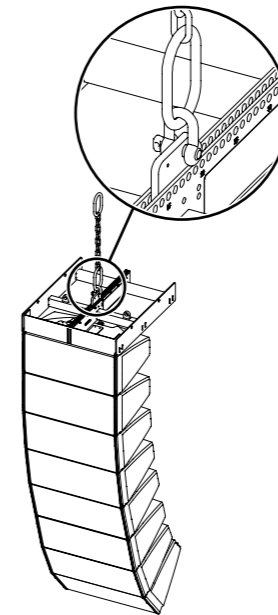

T10 or Ti10L line array with
Z5370 T Flying frame
Z5155 T/Q Hoist connector chain
E6507 1t Shackle

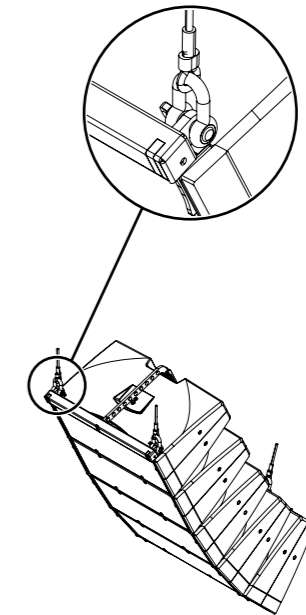

Ti10L line array with
Z5374 Ti Flying bar
E6507 1t Shackle

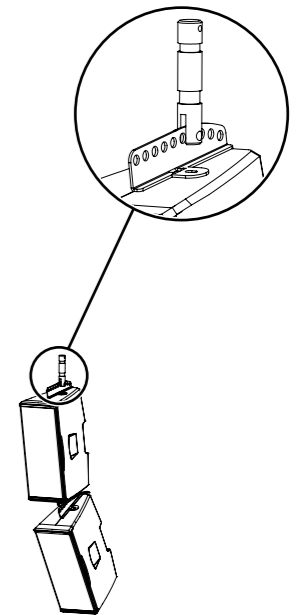

T10 point source or Ti10P
as vertical array with
Z5354 E8/E12 Flying adapter
Z5355 E8/E12 Flying adapter link
Z5015 TV Spigot 02

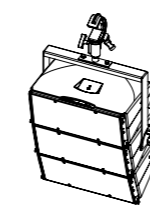

3 x T10 or Ti10L line array with
Z5373 T Cluster bracket
Z5010 TV Spigot with fixing plate
Z5012 Pipe clamp for TV Spigot



T10 point source or Ti10P with
Z5371 T Flying bracket
Z5010 TV Spigot with fixing plate
Z5012 Pipe clamp for TV Spigot

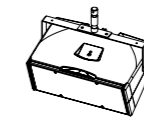

T10 point source or Ti10P with
Z5372 T Horizontal bracket
Z5010 TV Spigot with fixing plate

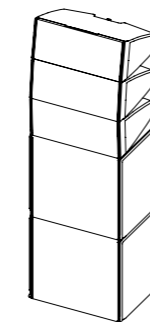

T10/T-SUB or Ti10L/Ti-SUB
ground stack

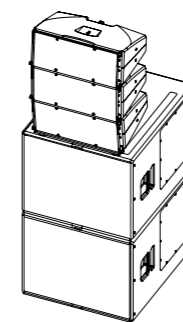

T10/B4-SUB ground stack
with Z5375 T Base plate

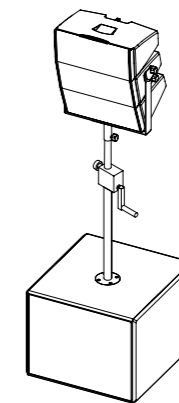

T10 or Ti10L line array
on Q-SUB with
Z5373 T Cluster bracket
Z5013 M20 pole with winder
Z5024 Loudspeaker stand adapter

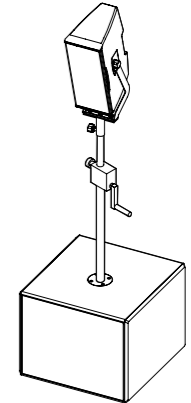

T10 point source or Ti10P
on E15X-SUB with
Z5371 T Flying bracket
Z5013 M20 pole with winder
Z5024 Loudspeaker stand adapter

The Ti Weather Resistant, Special Colour and Custom solutions options

Weather Resistant (WR) option

The WR option provides an IP54 rating, and enables operation of loudspeakers in changing ambient conditions, with some loudspeakers able to achieve an IP55 rating. However it is not intended to enable permanent, unprotected operation of loudspeakers outdoors. Cabinets used outdoors even with the WR option should always be aimed either horizontally or with a downward tilt. All WR speakers will be delivered without a cable. An optional WR cable (Z5763.000 - H07-RN-F 2 x 2.5 mm² / AWG 13, Faston connector type 2 x 6.3 mm male) with a standard length of 5.5 m is available. Other length on request.

Special Colour (SC) option

The paint finish of all loudspeaker cabinets and most accessories can be executed in almost any custom colour in accordance with common colour tables. All rigging fittings at the rear of the cabinet, Front links and Locking pins remain in black. Other paint finishes such as metallic are available on request. The acoustically transparent foam fitted behind the rigid metal grill is also painted with the requested special colour.

Custom solutions (SVS and SWR) option

SVS (Variants For Stadiums) loudspeakers have no integral rigging components, but instead, have threaded inserts in their side panels. The cabinets will be mechanically supported by metal brackets specifically designed for the respective application by Custom solutions.

SWR (Sea Water Resistant) loudspeaker models are based on WR or SVS variants where available, and withstand outdoor operation in wet and acid or salty environments like on cruise ships or coastal locations. Other custom solutions are available upon request.

The T-Series cases

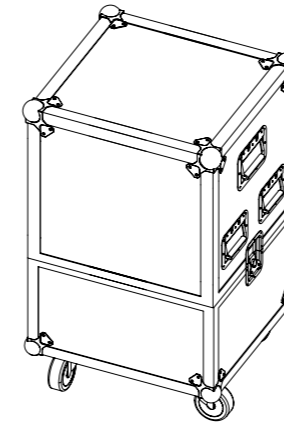

E7451
Touring case 4 x T10

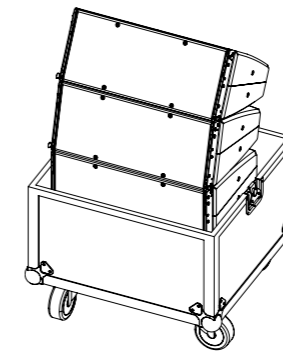

E7452
Touring case 2 x T10

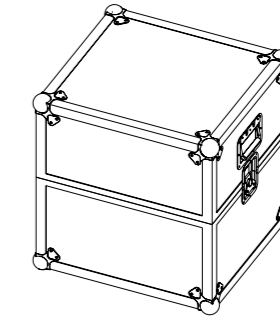

E7453
Touring case 2 x T-SUB

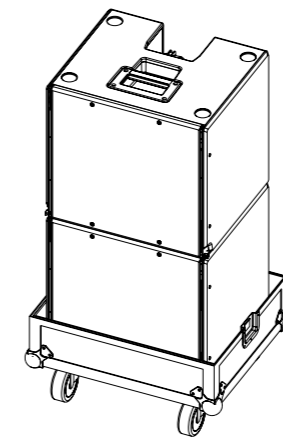

E7455
Touring case 2 x T Flying frame

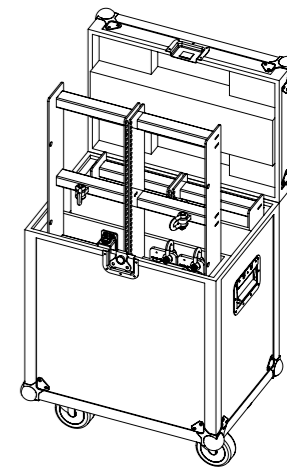
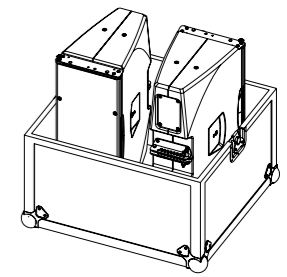

The d&b ArrayCalc simulation software

The d&b ArrayCalc simulation software is the prediction tool for d&b line arrays, column and point source loudspeakers as well as subwoofers. This is a comprehensive toolbox for all tasks associated with acoustic design, performance prediction, alignment, rigging and safety parameters. For safety reasons d&b line arrays must be designed using the ArrayCalc simulation software. ArrayCalc is available as a native stand-alone application for both Microsoft Windows¹ (Win7 64-bit or later) and Mac OS X² (10.12 or later) operating systems. In combination with the d&b Remote network, this can significantly reduce setup and tuning time in mobile applications and allows for precise simulations when planning installations. Listening planes can be defined in the venue tab, creating a three dimensional representation of any audience area in a given venue. This can also include balconies, side stalls, arenas, in the round scenarios or festivals. Special functions assist in obtaining accurate dimensions with laser distance finders and inclinometers.

Simulation

Up to forty flown arrays or subwoofer columns can be defined in a project file as single hangs or in pairs. A selection of d&b point source loudspeakers can also be fully integrated as well as a ground stacked SUB array consisting of up to eighty positions. All can be freely positioned according to their intended application, for example as main hang, outfill, nearfill or delay. Position, orientation, aiming and coverage details are displayed. Level over distance is calculated for each source with high resolution in real time, for either band limited or broadband input signals. The comprehensive simulation precisely models the actual performance of the system, taking into account input level, all system configuration options (such as CUT, CPL, HFC or INFRA), limiter headroom and air absorption. Acoustic obstacles, such as video screens, can be added to a model. Acoustic shadowing, whether by these obstacles, or a balcony overhang, is taken into consideration. The load status of all array rigging components is calculated accurately and displayed to determine whether a given array is within the load tolerance. Subwoofer array design is assisted by coverage and polar plot prediction. A specialized algorithm allows the user to specify subwoofer positions and a coverage angle, which is then converted into appropriate delay settings that result in the desired dispersion. The alignment tab enables different sources to be time aligned to one another, as well as showing arrival times and Sound Pressure Levels at a definable reference point on one of the audience areas. For alignment of the flown system with the ground stacked SUB array, the phase response of both the SUB array and a flown source is calculated at a definable reference point.

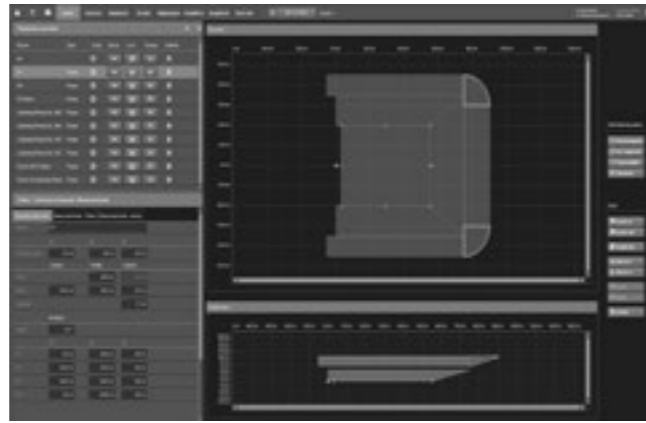

Venue

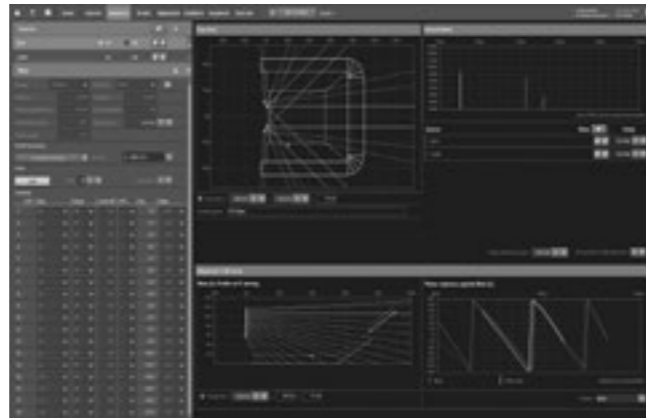

Alignment

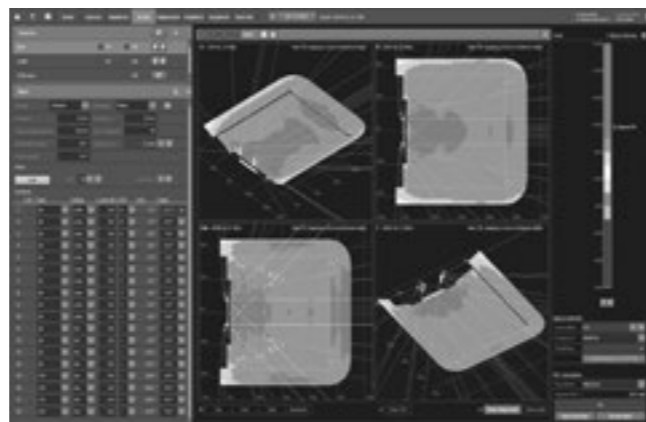

3D Plot quad

Both simulations reflect changes in delay time to the single sources in real time. The d&b ArrayCalc simulation software is available at www.dbaudio.com.

Prediction

The level distribution resulting from the interaction of all active sources can be mapped onto the audience areas in a three-dimensional view, which can also be zoomed, rotated and exported as a graphics file. EASE and DXF data export capabilities are also available. A rigging plot with all necessary coordinates, dimensions and weights of arrays is generated for export and printing and a parts list, detailing all components required. The d&b ArrayCalc Viewer app presents this key information for positioning and flying a d&b audiotechnik loudspeaker system on a mobile device. Once the system has been designed, calculated and optimized, all relevant project information can be shared via email, AirDrop, or downloaded onto any iOS or Android device.

ArrayProcessing

The optional ArrayProcessing function applies powerful filter algorithms to optimize the tonal (spectral) and level (spatial) performance of a line array column over the audience area defined by its mechanical vertical coverage angle. Temperature and Humidity Control (THC) for ArrayProcessing introduces a workflow that permits a system to adapt to changing atmospheric conditions in real time via R1. Within the d&b ArrayCalc simulation software, spectral and level performance targets over the listening areas can be defined while specific level drops or offsets can be applied to certain areas, to assign reduced level zones. ArrayProcessing applies a combination of FIR and IIR filters to each individual cabinet in an array to achieve the targeted performance, with an additional latency of only 5.9 ms. This significantly improves the linearity of the response over distance as well as seamlessly correcting for air absorption. In addition, ArrayProcessing employs the same frequency response targets for all d&b line arrays, to ensure all systems share a common tonality. The resulting coverage is enhanced with spectral consistency and defined level distribution, achieving more linear dispersion and total system directivity to cover longer distances or steep listening areas effectively.

R1 Remote Control Software

R1 uses the same project file created by ArrayCalc and generates an intuitive graphical user interface including complete details of the simulated system, loudspeakers, amplifiers, remote IDs, groups, ArrayProcessing data and all configuration information. This workflow removes the need to manually transfer data from one software program to the other.

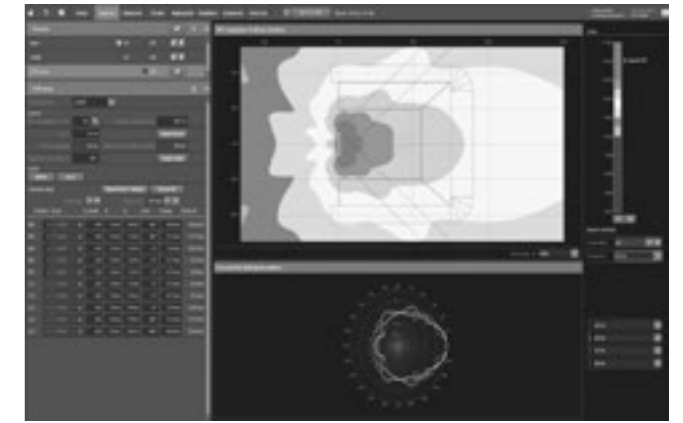

Sources, SUB array

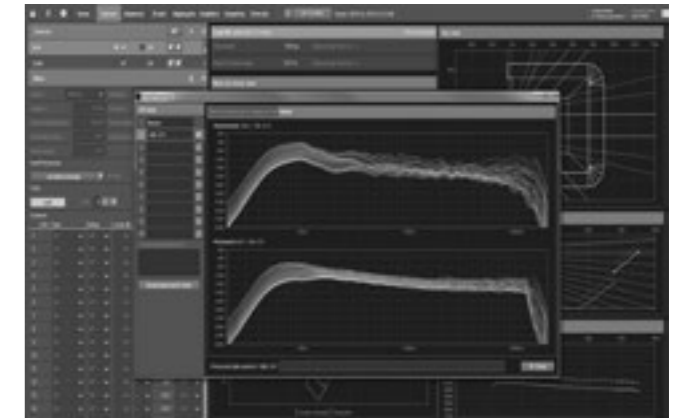

ArrayProcessing



Amplifiers

¹ Microsoft Windows is a registered trademark or trademark of Microsoft Corporation in the United States and/or other countries

² Mac OS X is a trademark of Apple Inc., registered in the U.S. and other countries

The d&b NoizCalc immission modelling software

The d&b software uses international standards to model the far field noise immission from multiple complex and coherently emitting sources such as line arrays and subwoofer arrays. More and more, gaining permission and licenses to stage live open air events requires an official statement with a prediction of how noise could impact on the surrounding area. NoizCalc takes all complex loudspeaker data and a reference point from the d&b ArrayCalc simulation software and calculates the sound propagation and relative attenuation values towards the far field for a certain scenario with particular meteorological conditions for one or more d&b loudspeaker systems.

A 3D terrain map imported from Google Maps or Street View displays the calculated immission on the areas surrounding the audience listening zones. This visual representation shows the actual system performance in the far field, enabling users to optimize for listeners while satisfying local noise restrictions and offsite regulations.

To ensure reliable results, NoizCalc includes all complex data concerning the addition and subtraction of sound waves, including phase information to describe the combination and interaction effects within a loudspeaker system consisting of multiple line arrays, subwoofer arrays and delay systems.

NoizCalc models immissions in the far field according to the internationally accepted ISO 9613-2 or Nord2000 calculation standards. Ground characteristics can be set depending on the absorbency or reflectivity of surfaces, while areas with volume attenuating properties can be defined. Buildings can be included, and the maximum reflection order option adjusts how many reflections are calculated. Parameters for humidity, air pressure and temperature ensure that the correct air absorption figures are accounted. The ISO 9613-2 standard requires limited meteorological information and assumes a worst-case scenario. The more sophisticated propagation model, Nord2000 enables a more precise handling of meteorological conditions allowing the user to model with prevailing wind information. The d&b NoizCalc immission modelling software is available at www.dbaudio.com for registered download, along with further information and video tutorials. It was developed in collaboration with SoundPLAN, a specialist software developer for environmental noise prediction.

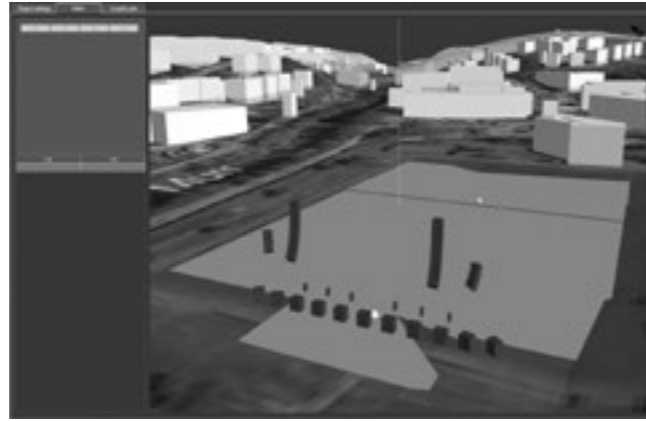

Editor



Graphic plot

The d&b R1 Remote control software

The remote control capability of the d&b Remote Network enables central control and monitoring of a complete d&b loudspeaker system from anywhere in the network, be it from a computer in the control room, at the mix position, or on a wireless tablet in the auditorium. This central access to all functions throughout the d&b Remote Network unlocks the full potential of the d&b system approach. In a typical user workflow, the d&b Remote Network takes settings optimized in the d&b ArrayCalc simulation software and applies these to all the amplifiers within the network.

All functions and controls available on the front panel of d&b amplifiers may be remotely controlled and/or monitored using the d&b R1 Remote control software. This allows each channel of the amplifier to be controlled and enables the creation of groups of loudspeakers. When grouped together, a button or fader can control the overall system level, zone level, equalization and delay, power ON/OFF, MUTE, as well as loudspeaker specific function switches such as CUT/HFA/HFC and CPL. An offline mode is provided for preparation in advance of an event, without the amplifiers being present or connected.

d&b System check verifies that the system performs within a predefined condition, while the Array verification function automatically identifies the physical position of a loudspeaker in an array to check that the system is cabled correctly. Extensive facilities for storing and recalling system settings are provided allowing these to be repeated, as and when required. For mobile applications, project files can be easily adjusted for use with a different set of equipment at another location.

In installation projects the R90 Touchscreen remote control can be used for quick and reliable operation of day-to-day functions of a pre-configured d&b system without needing expert level knowledge of audio. The built-in 7" panel PC provides users with one-touch control over power, mute, level, grouping and recall of up to nine AmpPresets, entirely independent of R1.

The R1 software is optimized for use with touch screen, mouse and keyboard and runs on both Microsoft Windows¹ (Win7 64-bit or later) and Mac OS X² (10.12 or later).

Further information is provided in the d&b Amplifier and Software brochure which is available for download at www.dbaudio.com.



Home



Remote in Configuration mode



16-band equalizer

¹ Microsoft Windows is a registered trademark or trademark of Microsoft Corporation in the United States and/or other countries
² Mac OS X is a trademark of Apple Inc., registered in the U.S. and other countries

The d&b amplifiers

The d&b amplifiers are designed specifically to power d&b loudspeakers and are the beating heart of the d&b System Reality. As such, they incorporate Digital Signal Processing for comprehensive loudspeaker management, switchable filter functions, remote capabilities and user-definable controls, to fulfil the exact needs of each application. Every loudspeaker configuration combines comprehensive system limiting, and equalization and crossover settings to ensure consistent results and optimal performance. d&b amplifiers offer

different output configurations for different loudspeaker setups, including Dual Channel mode, for passive setups, Mix TOP/SUB mode, in which two channels are driven through a single output connector, and 2-Way Active mode, which also sends the output of two channels down one connector to drive appropriate loudspeakers actively. The d&b switch functions provide selected filters to precisely tailor a wide variety of setups to their applications. Examples of these switch functions are the CSA (Cardioid Subwoofer Array)

and HFC (High Frequency Compensation) modes. CSA increases low frequency directivity control by minimising energy transmission towards the rear while HFC compensates for air absorption for loudspeakers covering far field listening positions. In addition to these functions, d&b amplifiers offer a comprehensive set of specific filters such as CUT, a cut mode for TOP loudspeakers when used with d&b subwoofers; CPL, to compensate for the coupling effect between loudspeakers in close proximity to other loudspeakers or hard objects and HFA

mode, to attenuate the high frequencies of a loudspeaker to mimic the effect of far field listening. These devices offer extended, user-definable equalization and delay capabilities, eliminating the need for external processing devices in the signal chain. All d&b amplifiers integrate with the d&b Remote network to enable the remote control and management of systems from anywhere within a network. Further information is provided in the d&b Amplifier and Software brochure which is available for download at www.dbaudio.com.

Comparison of the d&b amplifiers

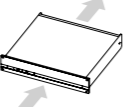
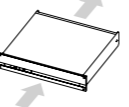
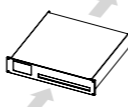
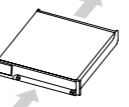
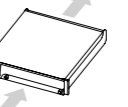
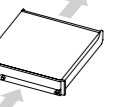
	5D	10D	30D	40D	D20	D40	D80
User interface	LED indicators	LED indicators	LED indicators	Colour TFT touchscreen	Encoder/colour TFT touchscreen	Encoder/colour TFT touchscreen	Encoder/colour TFT touchscreen
Output channels	4	4	4	4	4	4	4
Input channels	4 x Dante and 4 x analog	4 x AES3 and 4 x analog	4 x AES3 and 4 x analog	4 x AES3 and 4 x analog	4 x AES3 or 4 x analog or 2 x AES3 and 2 x analog	4 x AES3 or 4 x analog	4 x AES3 or 4 x analog or 2 x AES3 and 2 x analog
Latency	1.1 msec (analog) / < 4 msec (Dante)	0.3 msec	0.3 msec	0.3 msec	0.3 msec	0.3 msec	0.3 msec
User equalizers (per channel)	8-band	2 x 16-band	2 x 16-band	2 x 16-band	2 x 16-band	2 x 16-band	2 x 16-band
Delay	1.1 - 300 msec	10 sec/3440 m	10 sec/3440 m	10 sec/3440 m	10 sec/3440 m	10 sec/3440 m	10 sec/3440 m
Maximum output power (THD+N < 0.5%, 12 dB crest factor)	4 x 600 W into 4/8 ohms	4 x 350 W into 8 ohms 4 x 700 W into 4 ohms	4 x 800 W into 8 ohms 4 x 1600 W into 4 ohms	4 x 2000 W into 8 ohms 4 x 2400 W into 4 ohms	4 x 800 W into 8 ohms 4 x 1600 W into 4 ohms	4 x 2000 W into 8 ohms 4 x 2400 W into 4 ohms	4 x 2000 W into 8 ohms 4 x 4000 W into 4 ohms
Output routing		Dual Channel, Mix TOP/SUB 2-Way Active	Dual Channel, Mix TOP/SUB 2-Way Active	Dual Channel, Mix TOP/SUB 2-Way Active	Dual Channel, Mix TOP/SUB 2-Way Active	Dual Channel, Mix TOP/SUB 2-Way Active	Dual Channel, Mix TOP/SUB 2-Way Active
Output connectors	Phoenix Euroblock	Phoenix Euroblock	Phoenix Euroblock	Phoenix Euroblock	NL4 plus central NL8	NL4 plus central NL8	NL4 plus central NL8
GPIO connector	Phoenix Euroblock 4 ports (GPI)	Phoenix Euroblock 5 ports	Phoenix Euroblock 5 ports	Phoenix Euroblock 12 ports	No	No	No
Cable compensation	LoadMatch	LoadMatch	LoadMatch	LoadMatch	LoadMatch	LoadMatch	LoadMatch
Power supply	Universal range switched mode power supply with active PFC	Universal range switched mode power supply with active PFC	Universal range switched mode power supply with active PFC	Autosensing switched mode power supply with active PFC	Universal range switched mode power supply with active PFC	Autosensing switched mode power supply with active PFC	Autosensing switched mode power supply with active PFC
Mains voltage	100 - 240 V, 50 - 60 Hz	100 - 240 V, 50 - 60 Hz	100 - 240 V, 50 - 60 Hz	100 - 127/208 - 240 V, 50 - 60 Hz	100 - 240 V, 50 - 60 Hz	100 - 127/208 - 240 V, 50 - 60 Hz	100 - 127/208 - 240 V, 50 - 60 Hz
Weight (kg/lb)	4.6/10	10.6/23.4	10.6/23.4	13.3/29.3	10.8/23.8	13.8/30.4	19/42
Dimensions	1 RU x 9.5" x 405 mm	2 RU x 19" x 435 mm	2 RU x 19" x 435 mm	2 RU x 19" x 465 mm	2 RU x 19" x 460 mm	2 RU x 19" x 465 mm	2 RU x 19" x 530 mm
Remote	OCA/AES70 via Ethernet	OCA via Ethernet/CAN	OCA via Ethernet/CAN	OCA/AES70 via Ethernet	OCA via Ethernet/CAN	OCA/AES70 via Ethernet	OCA via Ethernet/CAN
Airflow							

The controller setups and operation with d&b amplifiers

Arc, Line and PS (point source) mode

The Line or Arc modes are selected when the T10 and Ti10L loudspeakers are used as a line array. The chosen configuration will depend on the curvature of the array. The Line configuration is selected when groups of four or more cabinets are coupled in a straight long throw array section, where the splay angles to adjacent cabinets are 0° to 2°. The Arc configuration is selected when cabinets are used in curved array sections, where the splay angles to adjacent cabinets are 3° or more. Within a typical array both amplifier configurations are used. The PS configuration is selected when the Ti10P is used in either horizontal or vertical orientation or the T10 is used as a single spherical loudspeaker.

CUT mode

Set to CUT, the cabinet low frequency level is reduced and is configured for use with d&b active subwoofers.

HFC mode

Selecting the HFC (High Frequency Compensation, Line or Arc mode only) mode compensates for loss of high frequency energy due to absorption in air when loudspeakers are used to cover far field listening positions. The HFC mode has two different settings, which should only be used for those cabinets covering the following respective distances: HFC1 for distances between 25 m (80 ft) and 50 m (160 ft), and HFC2 for distances further than 50 m (160 ft). This enables the correct sound balance between close and remote audience areas, whilst all amplifiers driving the array can be fed with the same signal.

HFA mode

Selecting HFA mode (High Frequency Attenuation, PS setup only), the HF response is rolled off. The HFA provides a natural, balanced frequency response when a unit is placed close to listeners in near field or delay use. HFA begins gradually at 1 kHz, dropping by approximately 3 dB at 10 kHz. This roll off mimics the decline in frequency response experienced when listening to a system from a distance in a typically reverberant room or auditorium.

CPL function

The CPL (Coupling) function compensates for coupling effects between closely coupled cabinets by reducing the low and mid frequency level. CPL begins gradually at 1 kHz, with the maximum attenuation below 400 Hz, providing a balanced

frequency response when cabinets are used in arrays of four or more. The CPL function can be set in dB attenuation values between -9 and 0, or a positive CPL value which creates an adjustable low frequency boost around 65 Hz (0 to +5 dB).

100 Hz mode

The 100 Hz mode limits the upper operating frequency of the subwoofer to 100 Hz, complementing top cabinets in full range mode.

Recommended amplifiers for mobile applications

	T10	T-SUB	B4-SUB
D20	x	x	x
D40	x	x	x

Recommended amplifiers for installation applications

	Ti10L	Ti10P	Ti-SUB
5D	x	x	
30D	x	x	x
40D	x	x	x

Maximum loudspeakers per amplifier channel

	T10	Ti10L	Ti10P	T-SUB/ Ti-SUB	B4-SUB
	4	4	4	2	2
with 5D	2	2	2	1	

Available controller settings

	T10	Ti10L	Ti10P	T-SUB/ Ti-SUB	B4-SUB
Arc, Line	x	x			
PS	x		x		
CUT	x	x	x		
HFC	x	x			
HFA	x		x		
CPL	x	x	x		

The T-Series frequency responses

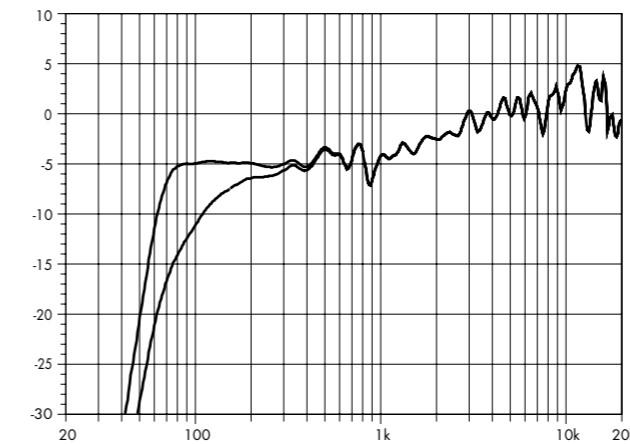

T10 line source/Ti10L standard and CUT (single cabinet)

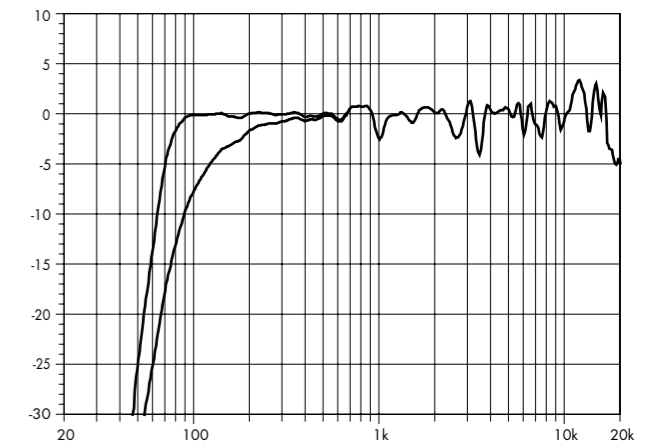

T10 point source/Ti10P standard and CUT

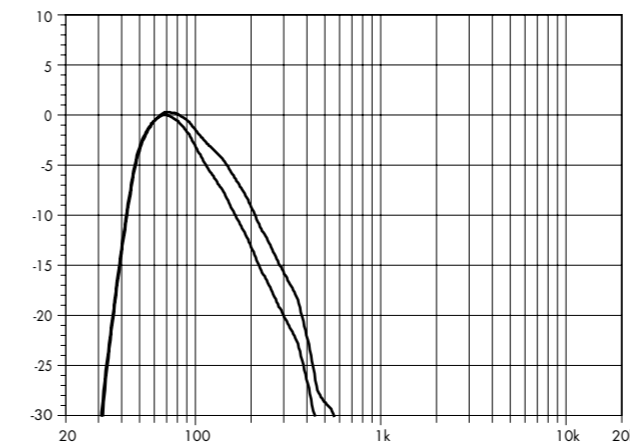

T-SUB standard and 100 Hz

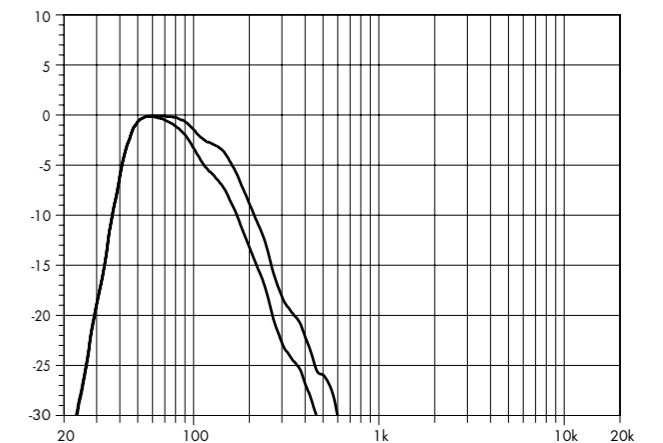

B4-SUB standard and 100 Hz

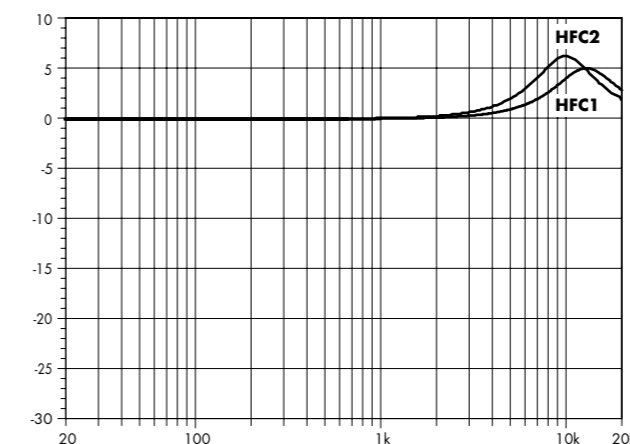

Correction of HFC

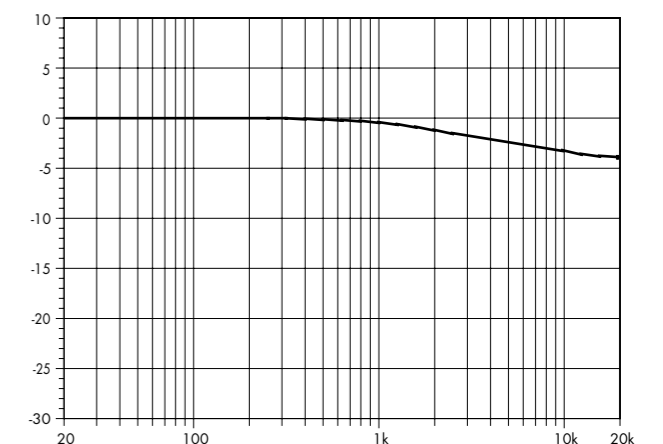

Correction of HFA

The d&b amplifier output modes

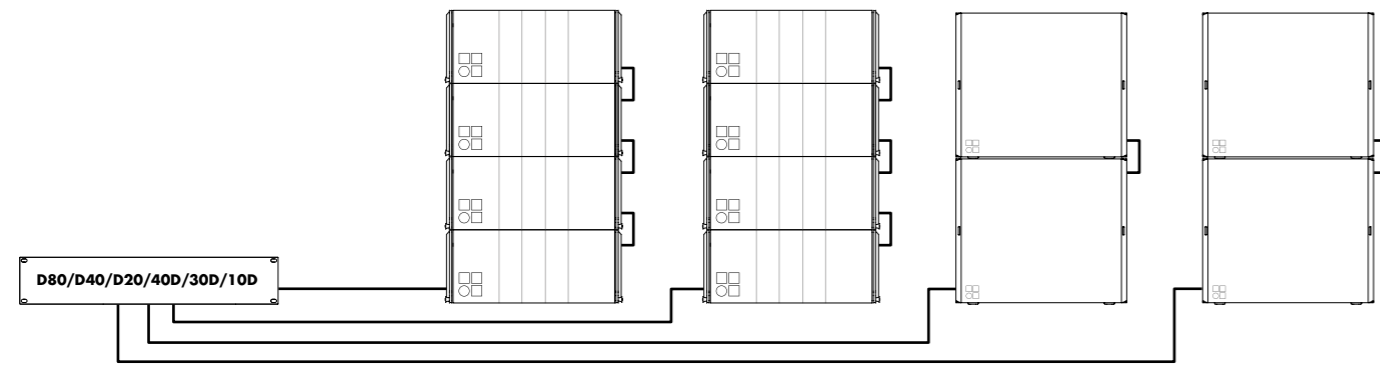

D80/D40/D20/40D/30D/10D amplifier in Dual Channel mode for T10, Ti10L, Ti10P, T-SUB, Ti-SUB and B4-SUB¹

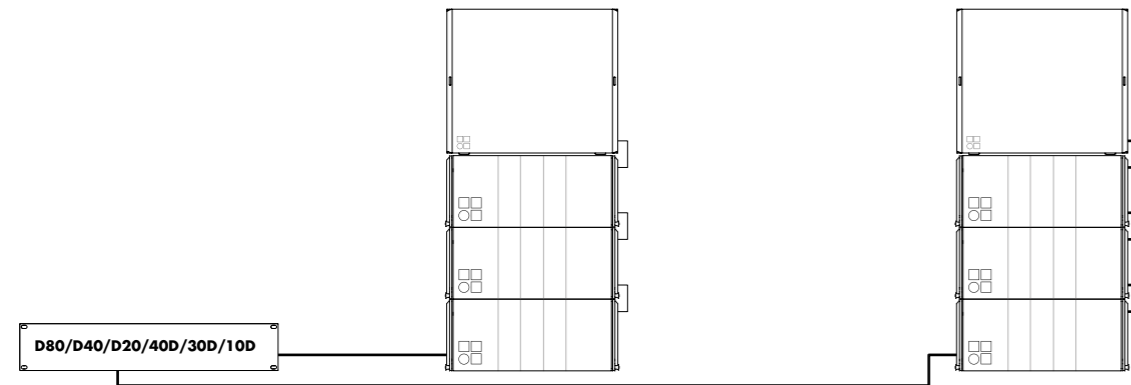

D80/D40/D20/40D/30D/10D amplifier in Mix TOP/SUB mode for T10, Ti10L, Ti10P, T-SUB, Ti-SUB and B4-SUB¹

The DS10 and DS20 Audio network bridges The DS100 Signal Engine

DS10 Audio network bridge

The DS10 Audio network bridge interfaces between Dante networks and AES3 digital audio signals, while also providing distribution of Ethernet control data. Positioned within the signal chain in front of the amplifiers, this 1 RU device expands the d&b system approach. Each unit can deliver up to sixteen Dante network channels via AES3 digital signal outputs. Additionally, four AES3 input channels provide access to the Dante audio network for applications such as a break-in from a Front of House console. The DS10 incorporates an integrated 5-port switch, offering a primary and redundant network for the Dante protocol, as well as advanced functions such as Multicast Filtering and VLAN modes. Using the DS10 Audio network bridge, audio signals and remote control data can be combined using a single Ethernet cable.



The DS10 Audio network bridge front view



The DS10 Audio network bridge rear view

DS20 Audio network bridge

The DS20 Audio network bridge supports the open standards-based Milan protocol rather than Dante. Milan (Media integrated local area networking) is a high level interoperability solution based on Audio Video Bridging (AVB) technology. The main advantages are deterministic behaviour (zero network congestion); improved reliability; optimum synchronization and hassle free network setup, as no special settings, such as QoS, need to be set within the switches to ensure delivery.



The DS20 Audio network bridge front view



The DS20 Audio network bridge rear view

DS100 Signal Engine

The d&b DS100 Signal Engine is the platform underneath the Soundscape, based on a specialized rack mount 3 RU audio processor with Audinate Dante networking. It provides a 64 x 64 audio matrix with level and delay adjustments at all cross points. Additional software modules provide dynamic source positioning and emulated acoustics functions. The DS100 is a versatile tool for use within complex audio systems to route and distribute multiple audio channels to numerous amplifiers driving loudspeaker positions and zones, show relay and break out rooms. The networking capabilities with a Dante enabled processor are significant, particularly for busy, multi-room complexes. The DS100 completely integrates with the overall d&b system approach, including loudspeakers, amplifiers, rigging, transport and networking accessories and the DS10 Audio network bridge. The complete system is designed and optimized in the d&b ArrayCalc simulation software, and controlled via the d&b R1 Remote control software.



The DS100 Signal Engine front view

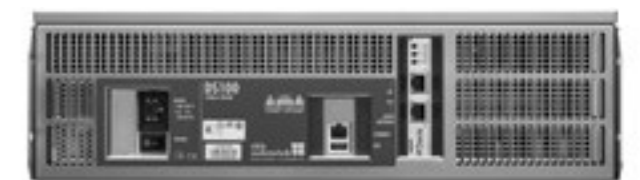

The DS100 Signal Engine rear view

The T-Series configuration examples

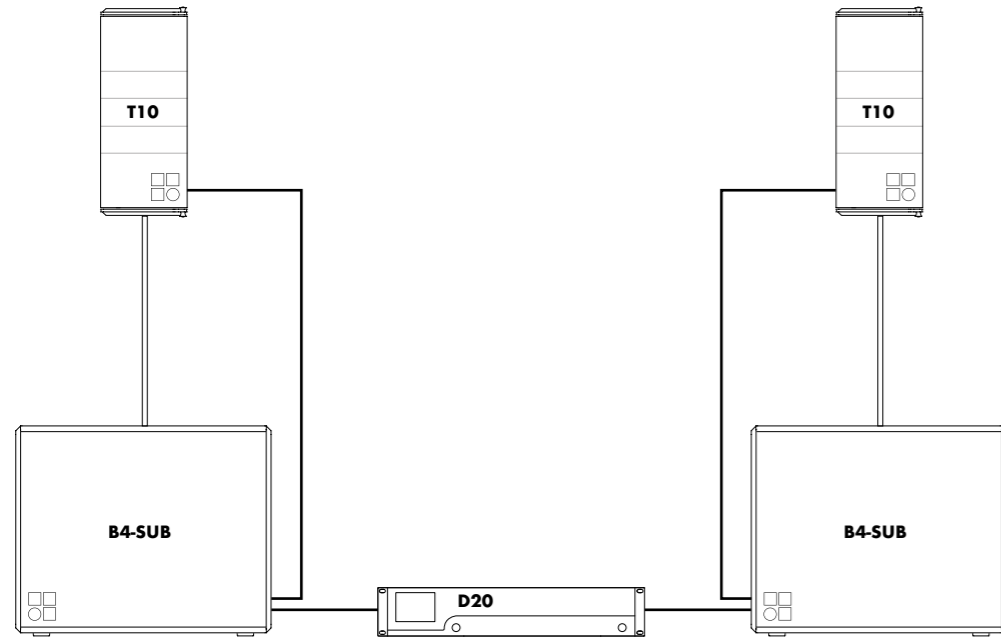

T10 loudspeakers in point source orientation on B4-SUBs with a D20 amplifier in Mix TOP/SUB mode¹

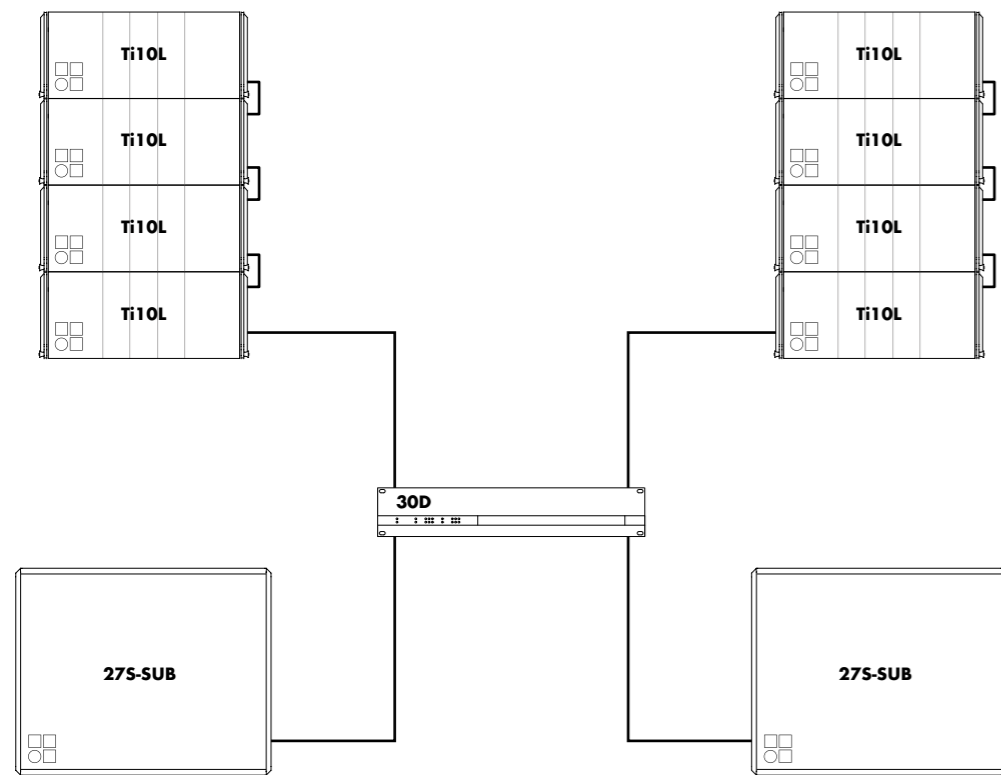
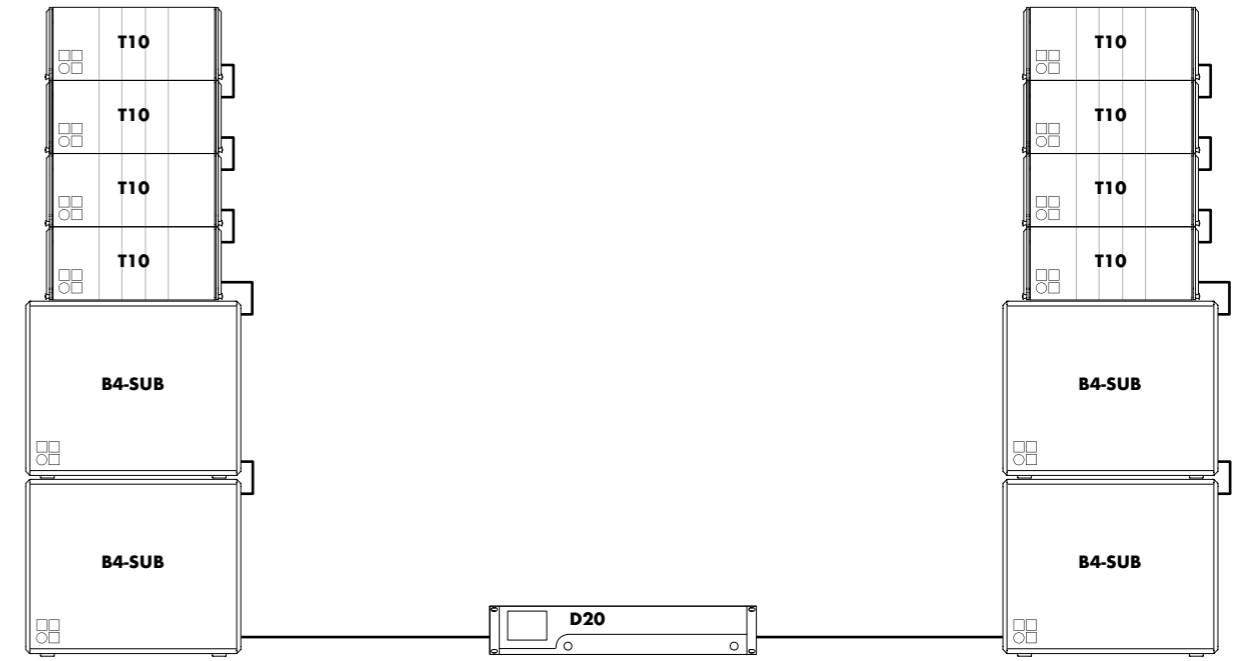

Ti10L line array on 275-SUBs with a 30D amplifier in Dual Channel mode

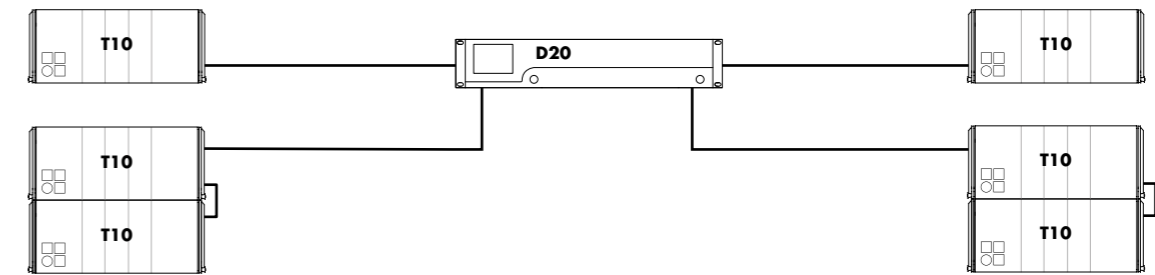

T10 line array on B4-SUBs ground stacked in left/right configuration with D20 amplifier in Mix TOP/SUB mode and delay with D20 amplifier in Dual Channel mode

The T-Series configuration examples

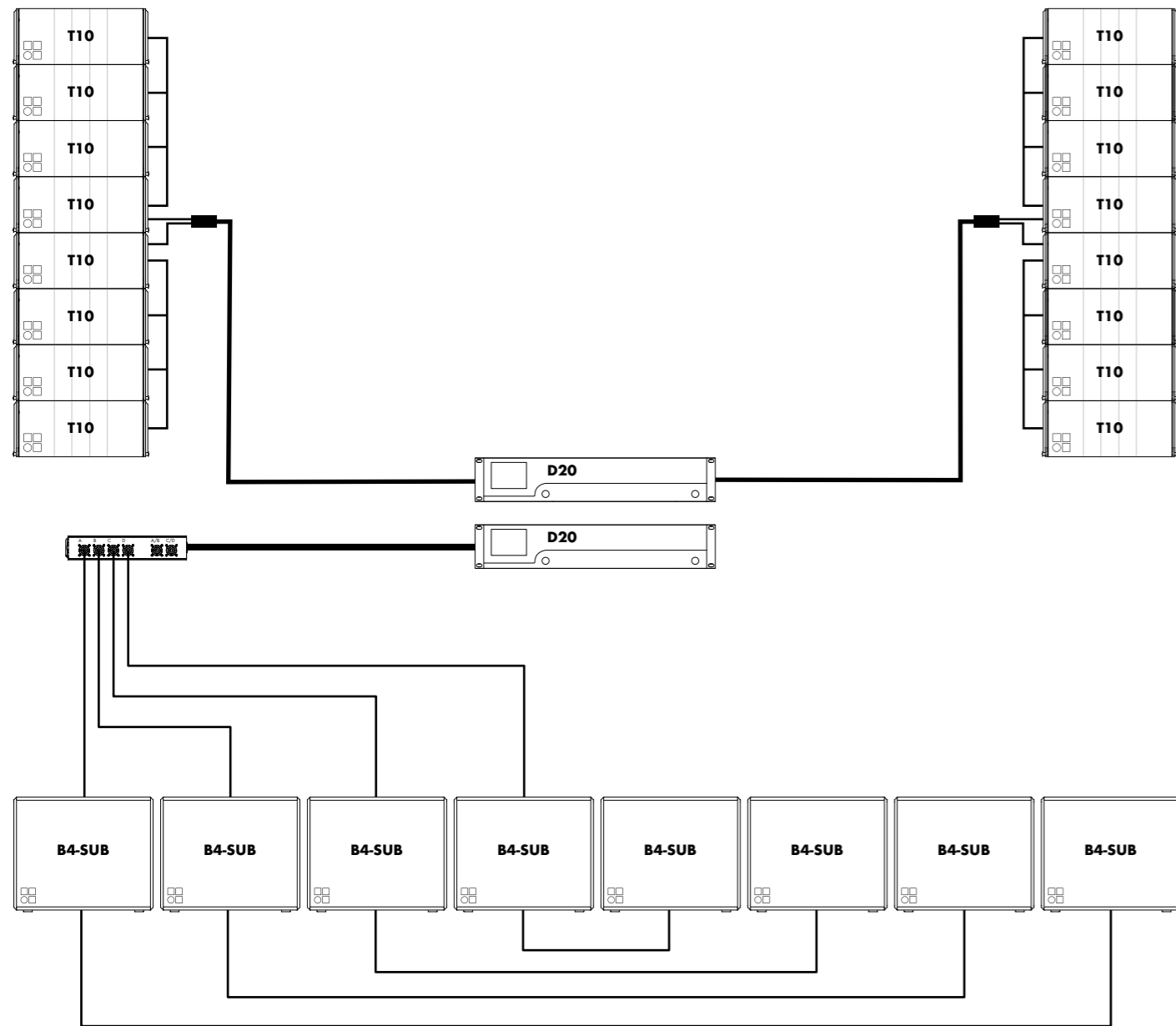

T10 flown line arrays in left/right configuration and ground stacked B4-SUB array with D20 amplifiers in Dual Channel mode¹

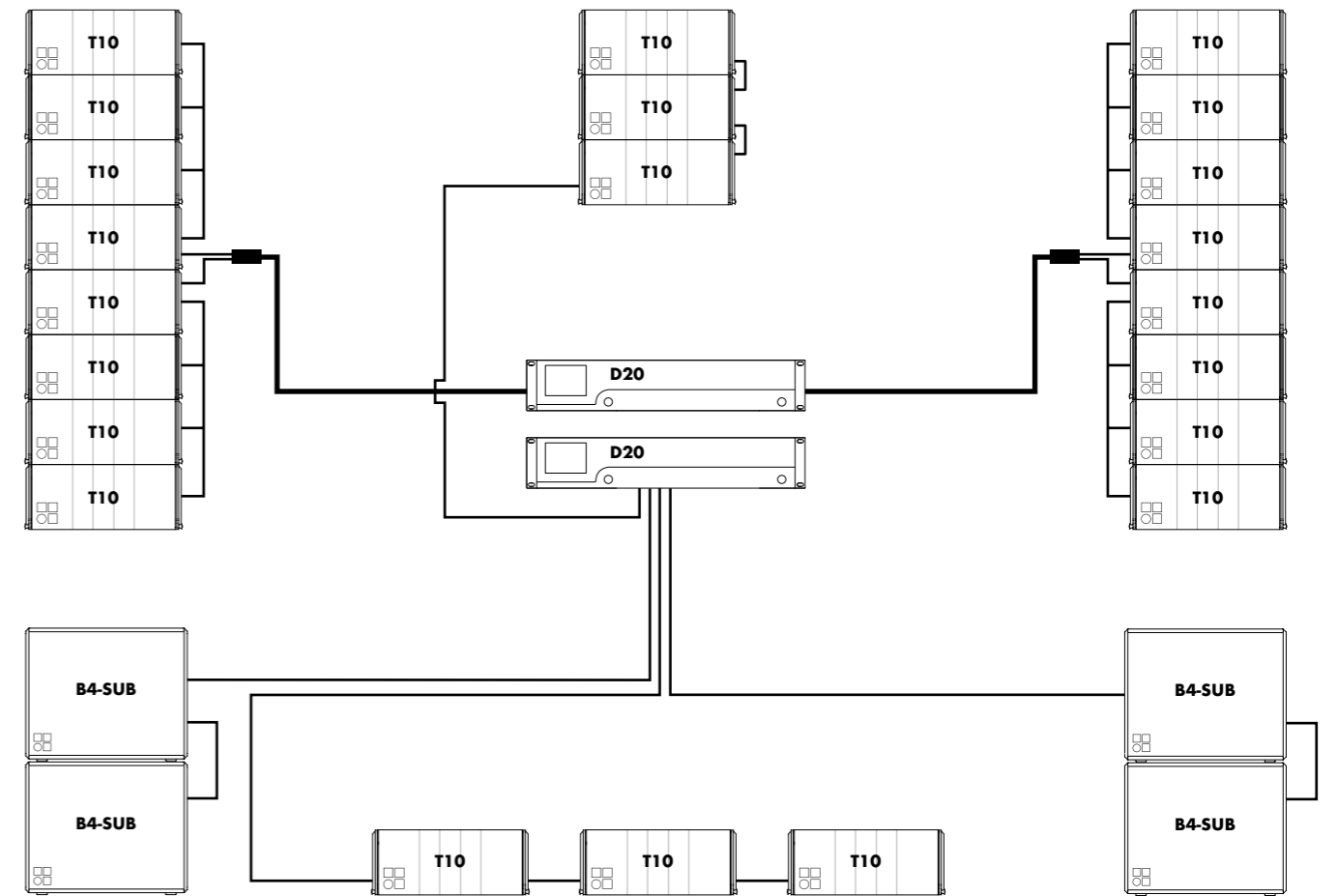

T10 flown line arrays in left/right configuration and centre cluster with T10 frontfills and ground stacked B4-SUBs on D20 amplifiers in Dual Channel mode¹

The T-Series cables and adapters MC8 / MC4

Amplifiers in Dual Channel mode

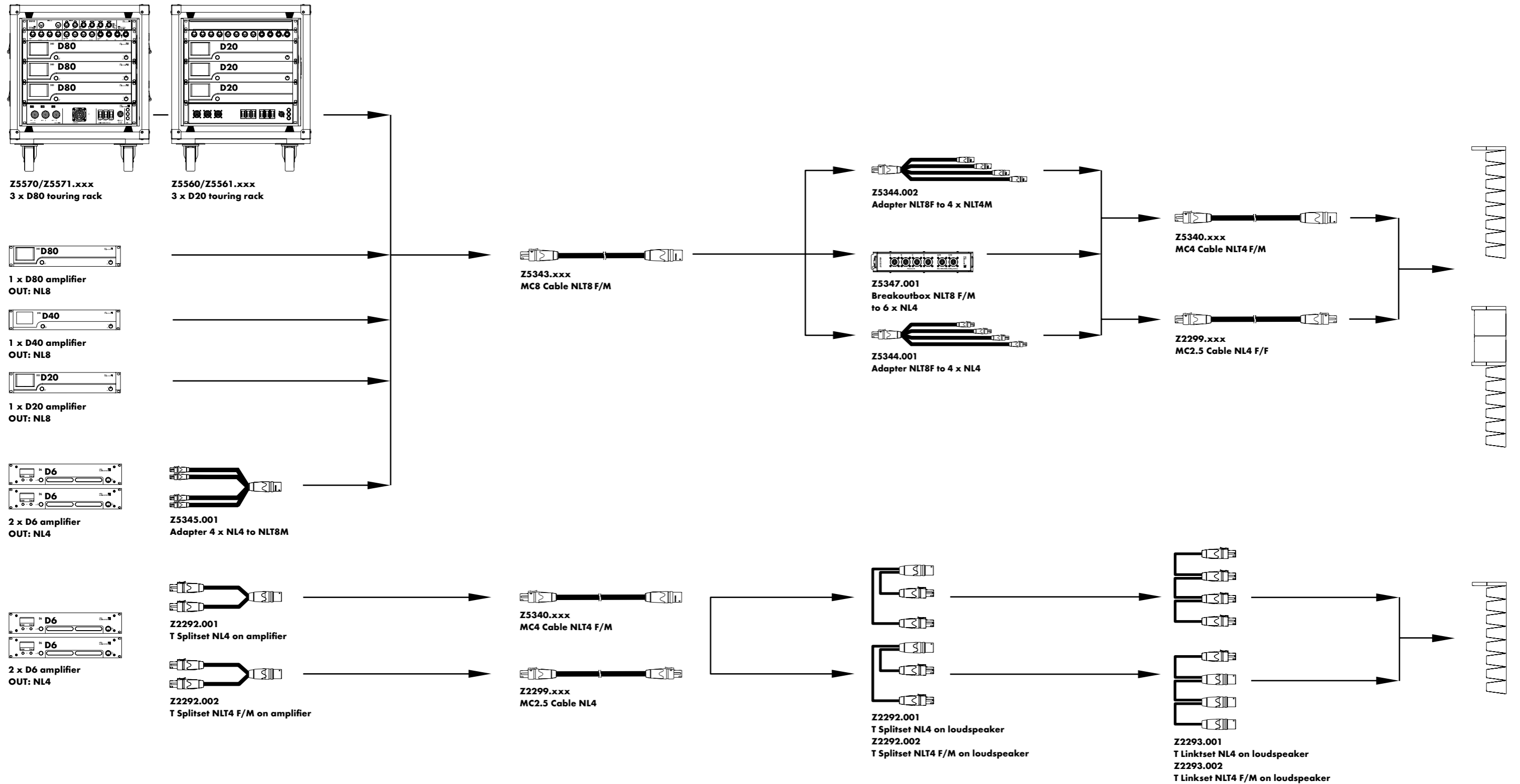

The T-Series cables and adapters MC24 - LKA25 / MC8

Amplifiers in Dual Channel mode

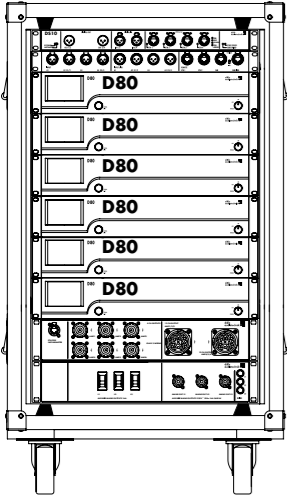

Z5576
D80 Touring rack assembly
OUT: 2 x LKA25F/6 x NL8

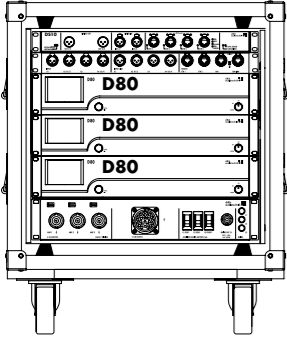

Z5570/Z5571.xxx
OUT: LKA25F/3 x NL8

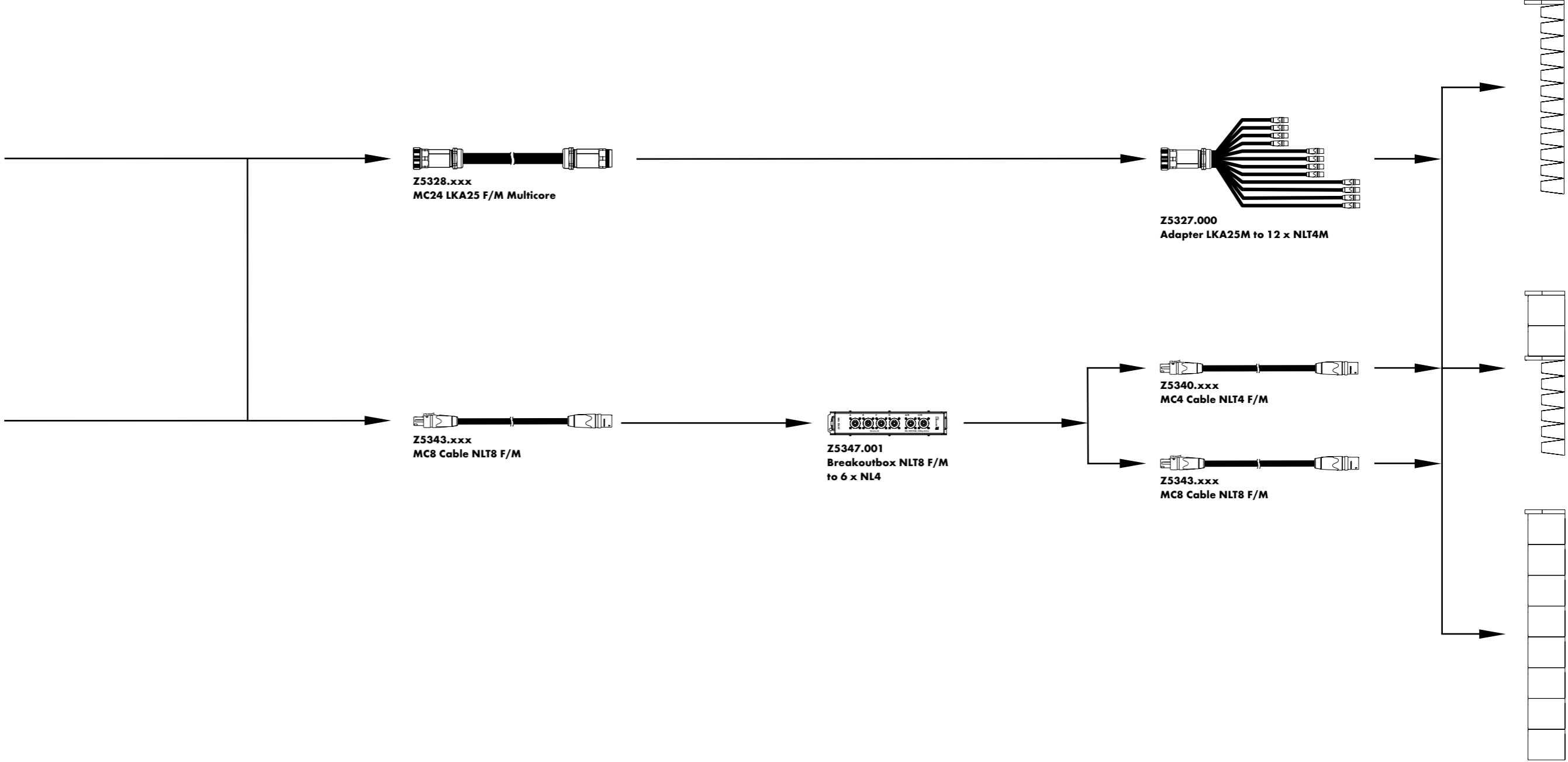

The T-Series product overview

T loudspeakers	Z0550.xxx Z0560.xxx Z0610.xxx	T10 loudspeaker T subwoofer B4 subwoofer	Processing and distribution	Z4010.000 Z4011.000 Z4100.000	DS10 Audio network bridge DS20 Audio network bridge DS100 Signal Engine
Loudspeaker connector options	Zxxxx.002 Zxxxx.001	NLT4 F/M connector NL4 connector	Amplifiers	Z2750.xxx Z2850.xxx Z2710.xxx Z2880.xxx Z2760.xxx Z2770.xxx Z2830.xxx	D20 Amplifier ⁴ D40 Amplifier ⁴ D80 Amplifier ⁴ 5D Amplifier ⁵ 10D Amplifier ⁵ 30D Amplifier ⁵ 40D Amplifier ⁵
Ti loudspeakers	Z0551.001 Z0552.001 Z0561.001	Ti10L loudspeaker NL4 connector Ti10P loudspeaker NL4 connector Ti subwoofer NL4 connector WR Weather Resistant option ¹ SC Special Colour option ²	Amplifier rack assemblies	Z5560.xxx Z5561.xxx Z5330.xxx Z5562.xxx	3xD20 Touring rack ⁶ 3xD20 Touring rack (includes DS10) ⁶ D80 Touring rack ⁶ D80 Touring rack (includes DS10) ⁶
Loudspeaker cases	E7451.000 E7452.000 E7453.000 E7455.000	Touring case 4 x T10 sleeve, wheels Touring case 2 x T10 lid Touring case 2 x T-SUB sleeve, wheels Touring case 2 x T Flying frame lid, wheels	Amplifier racks	E7480.000 E7468.000 E7483.000	D20 Touring rack 2 RU, 19" SD, shock mounted, handles D80 Touring rack 2 RU, 19" SD, shock mounted, handles DS100 Touring rack 3 RU, 19" SD, shock mounted, handles
Lid	E7922.000	B4-SUB Wooden lid	Cables and adapters	Z5339.000 Z5343.xxx Z5345.001 Z5344.002 Z5344.001 Z5347.001 Z5340.xxx Z2293.002 Z2293.001 Z2292.002 Z2292.001 Z5328.xxx Z5327.000 Z2299.xxx Z5763.000	Multichannel extension cable MC8 Cable NLT8 F/M Adapter 4 x NL4 to NLT8M Adapter NLT8F to 4 x NLT4M Adapter NLT8F to 4 x NL4 Breakoutbox NLT8 F/M to 6 x NL4 MC4 Cable NLT4 F/M T Linkset NLT4 F/M T Linkset NL4 T Splitset NLT4 F/M T Splitset NL4 MC24 LKA 25 F/M Multicore Adapter LKA25M to 12 x NLT4M MC2.5 Cable NL4 F/F WR 5,5m cable 2x2.5mm ^{2,7}
Accessories	Z5370.000 Z5374.000 Z5371.000 Z5372.000 Z5373.000 Z5354.000 Z5355.000 Z5010.000 Z5015.000 Z5029.000 Z5009.000 Z5013.000 Z5024.000 Z5034.000 Z5012.500 Z5147.001 Z5155.000 E6507.000 Z5375.000	T Flying frame ³ Ti Flying bar ³ T Flying bracket ³ T Horizontal bracket ³ T Cluster bracket 3 deep ³ E8/E12 Flying adapter ³ E8/E12 Flying adapter link TV Spigot with fixing plate TV Spigot for flying adapter 02 TV Spigot M10 Loudspeaker stand with winder M20 pole with winder Loudspeaker stand adapter Stand adapter M10 Pipe clamp for TV Spigot Rota clamp T/Q Hoist connector chain 1t Shackle T Base plate ³	Remote network	Z6118.000 Z6124.000 Z6126.000	R60 USB to CAN interface R70 Ethernet to CAN interface R90 Touchscreen remote control

¹ WR only for Ti loudspeakers, on request

² SC only for Ti loudspeakers

³ SC on request

⁴ The complete list of mobile amplifier versions is available in the d&b D Amplifier and Software brochure

⁵ The complete list of installation amplifier versions is available in the d&b xD Installation Amplifier and Software brochure

⁶ Further information is available in the d&b D Amplifier and Software brochure

⁷ Other lengths on request

