

Y

Y-Series



Contents



The d&b System reality	4
The Y-Series	6
The Y7P loudspeaker and Yi7P loudspeaker	10
The Y10P loudspeaker and Yi10P loudspeaker	11
The B6 subwoofer and Bi6 subwoofer	12
The Y7P, Y10P and B6 transport accessories	13
The Y8 loudspeaker and Yi8 loudspeaker	14
The Y12 loudspeaker and Yi12 loudspeaker	15
The Y subwoofer and Yi subwoofer	16
The Y8, Y12 and Y-SUB transport accessories	17
The Y-Series mounting accessories and examples	18
The Y-Series rigging accessories and examples	22
The Yi Weather Resistant, Special Colour and Custom solutions options	25
The d&b ArrayCalc simulation software	26
The d&b NoizCalc immission modelling software	28
The d&b Remote network	29
The d&b amplifiers	30
The controller setups and operation with d&b amplifiers	32
The Y-Series frequency responses	33
The d&b amplifier output modes	34
The DS10 and DS20 Audio network bridges	36
The DS100 Signal Engine	36
The Y-Series configuration examples	37
The Y-Series cables and adapters	42
The Y-Series product overview	46

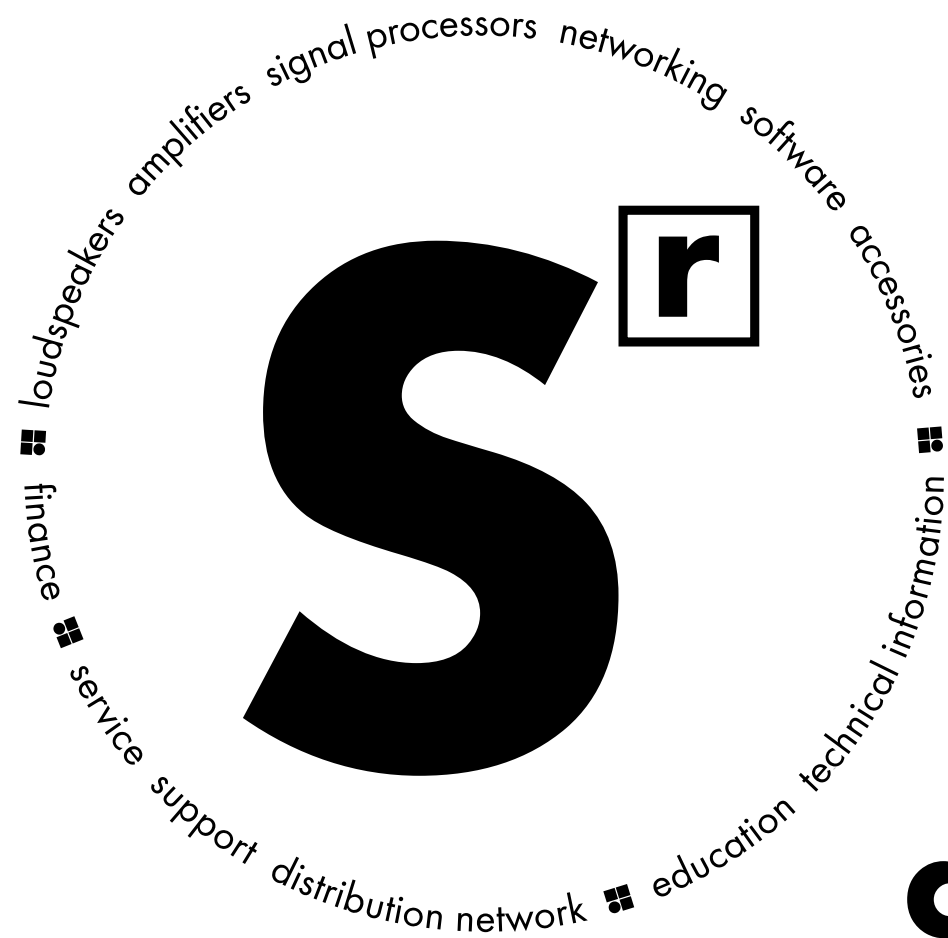

d&b System reality

As the name implies a d&b audiotechnik system is not just a loudspeaker. Nor is it merely a sum of the components: loudspeakers, amplifiers, signal processors, networking, software and accessories. Right from the outset the d&b audiotechnik approach was to build integrated sound reinforcement systems

that actually are more than the combination of parts: an entirety where each fits all. Every element is tightly specified, precisely aligned and carefully matched to achieve maximum efficiency. For ease of use, all the user-definable parameters are incorporated, allowing the possibility of adjustment, either

directly, via remote control surfaces, or integrated within wider networks. Neutral sound characteristics leave the user all the freedom needed to realize whatever the brief. At the same time d&b offers finance, service and support, a knowledgeable distribution network, education and training as well as technical

information, so the same optimal acoustic result is achieved consistently by every system anywhere, at any time. In reality: the d&b System reality.



The **Y-Series** loudspeakers are designed with a clear perspective to provide flexible and configurable solutions, even in the most arduous sound reinforcement situations. Performing arts, conferences, religious events and live shows; applications all demanding strict qualities in the performance, look and feel of a loudspeaker. On one side the Y-Series provides adept small to

medium scale, stand alone or distributed point source solutions, whereas on the other hand the wide spectrum of mid-sized line array potential is inherited from its bigger brothers, the V-Series and J-Series. Flexible horizontal dispersion characteristics combined with either rotatable horns or innovative custom waveguides ensure constant directivity over a wide bandwidth.

Dipolar driver arrangements deliver accurate dispersion control, while a deep LF performance is derived from the bass-reflex design. Three point rigging systems are integrated into the arrayable cabinets, even the cardioid subwoofer, these, together with ground stacking options, present an abundance of opportunity for deployment. The **Yi loudspeakers** differ only

slightly in cabinet construction, finish and mounting hardware. They are intended for permanently installed performance spaces where the specification is rider driven by the artist or mix engineer's preferences. Both the Yi cabinets and mounting hardware can be properly colour matched to interior designs and weather protected for climatically hostile environments.

The Y-Series

The **Y7P** and **Yi7P** as well as the **Y10P** and **Yi10P** point source loudspeakers both feature the same dipolar arrangement with two 8" drivers centered around a 1.4" HF compression driver mounted on a CD horn with 75° x 40° and 110° x 40° dispersion characteristics respectively. A rotatable horn enables deployment in either orientation, whilst an innovative bass-reflex and port design gives an increased LF performance. The high performance omnidirectional **B6** and **Bi6-SUB** feature a single 18" long excursion driver, intended for ground stacked applications only.

The **Y8** and **Y12** and the installation specific **Yi8** and **Yi12** line array modules also share the same driver arrangement, with two 8" dipolar mounted drivers and a 1.4" HF driver combined with a central wave transformer. The advanced bass-reflex and port arrangement delivers full bandwidth capabilities with an extended LF output. Due to the dipolar arrangement of the LF drivers, a broadband, horizontal directivity control is maintained down to approximately 500 Hz for the different dispersion options, 80° for the Y8 and 120° for the Y12. The arrayable, cardioid **Y** and **Yi** subwoofers both house two long excursion neodymium drivers, powered by a single amplifier channel. The 18" and 12" drivers arranged in an integrated cardioid setup, avoid unwanted energy behind the system.

All Y loudspeakers are finished with a PCP (Polyurea Cabinet Protection) coating that provides mobile systems with protection against impact and resistance to the adverse effects on cabinets caused by changing ambient outdoor conditions. The Yi cabinets feature an impact resistant paint finish; Weather Resistant and Special Colour options are available.

The d&b software offering aides the entire system setup process. The **d&b ArrayCalc simulation software** allows the virtual optimization of loudspeaker line arrays, point source and column loudspeakers as well as subwoofers and their adjustment to venue conditions. The **d&b NoizCalc immission modelling software** uses international standards to model noise immission from d&b loudspeaker systems. NoizCalc takes data from ArrayCalc and calculates the sound propagation towards the far field. The complete system configuration simulated in ArrayCalc is assimilated by the **d&b R1 Remote control software** into an intuitive graphical user interface to manage the amplifiers, and loudspeakers, from anywhere in the venue. The **R90 Touchscreen remote control** provides quick, reliable, and effortless operation of day-to-day functions of a preconfigured d&b system, without needing expert level knowledge of audio.



Y7P, Y10P loudspeaker



Yi7P, Yi10P loudspeaker



B6 subwoofer



Bi6 subwoofer



Y8, Y12 loudspeaker



Yi8, Yi12 loudspeaker



Y subwoofer



Yi subwoofer



R90 Touchscreen remote control

A wide range of tools and data files are available to support the planning process using external tools. For enhanced acoustic simulations, all loudspeakers offer EASE files. The planning process using BIM (Building Information Modelling) is supported with Revit files available for all loudspeakers and accessories, creating accurate project data and visualisation. Additionally, our 2D and 3D CAD data is usable in most common planning tools. Venue data created by SketchUp can be imported to ArrayCalc using the d&b sketchup plug-in to facilitate system design.

d&b amplifiers are specifically designed for use with d&b loudspeakers, and are at the heart of the d&b system approach. These devices contain extensive Digital Signal Processing capabilities to provide comprehensive loudspeaker management and specific switchable filter functions to precisely target the system response for a wide variety of applications. The four channel **D40** and **D80** amplifier are intended for mobile applications requiring the highest Sound Pressure Levels. The installation specific four channel **30D** and **40D** amplifiers are intended for permanent integration within venues which require medium to high Sound Pressure Levels. These amplifiers all provide extensive user-definable equalization containing two 16-band equalizers with parametric, notch, shelving and asymmetric filters as well as delay capabilities of up to 10 seconds.

The d&b Audio network bridges interface between audio transport networks and AES3 digital audio signals while also providing distribution of Ethernet control data. The **DS10** supports Dante networks, while the **DS20** is used for the open standards-based Milan protocol.

The **DS100 Signal Engine** is based on a specialized rack mount 3 RU audio processor with Audinate Dante networking. It provides a 64 x 64 audio matrix with level and delay adjustments at all cross points. Additional software modules provide dynamic source positioning and emulated acoustics functions.

An extensive range of standardized transport solutions is offered for the Y-Series, consisting of touring cases, touring carts as well as transport lids. Complete cabling structures including multicores and breakouts are also available, alongside extensive mounting options. Amplifier Touring rack assemblies can be provided for either three D20 amplifiers, three D80 amplifiers, or six D80 amplifiers. The DS10 Audio network bridge can be supplied in these fully equipped system racks, which also house mains power distribution units, connector interfaces and all internal cabling.



D80 amplifier



D40 amplifier



30D amplifier



40D amplifier



DS10 Audio network bridge



DS20 Audio network bridge



DS100 Signal Engine

The Y7P loudspeaker

The Yi7P loudspeaker

Y7P/Yi7P loudspeaker

The compact, 2-way passive Y7P loudspeaker and Yi7P loudspeaker feature two 8" drivers in a dipole arrangement with a 1.4" compression driver mounted onto a rotatable CD horn. The Yi7P is the installation version of the Y7P loudspeaker and differs only in cabinet construction, finish and mounting hardware. Sophisticated horn geometry combined with the advanced bass-reflex port design delivers full bandwidth capabilities with an extended LF output. These point source, high performance cabinets offer 75° horizontal directivity matched with a vertical dispersion of 40°; the horn can be rotated by 90° to enable horizontal orientation.

The Y7P/Yi7P provide a broad variety of deployment possibilities, especially when used as a stand-alone full range system, or combined with other elements from the Y-Series, either ground stacked or flown.

The loudspeaker cabinets are constructed from marine plywood, the Y7P has an impact and weather protected PCP (Polyurea Cabinet Protection) finish, while the Yi7P has an impact resistant paint finish. The front of the loudspeaker cabinets are protected by a rigid metal grill. The Y7P cabinet incorporates a pair of handles whilst M10 threaded inserts are provided for attaching d&b rigging hardware.

System data

Frequency response (-5 dB standard)	59 Hz - 18 kHz
Frequency response (-5 dB CUT mode)	118 Hz - 18 kHz
Max. sound pressure (1 m, free field) ¹	
with D6/10D	132 dB
with 30D/D20	135 dB
with D40/40D ³	137 dB
with D80	137 dB

Loudspeaker data

Nominal impedance	8 ohms
Power handling capacity (RMS/peak 10 ms)	400/1600 W
Nominal dispersion angle (h x v)	75° x 40°
Components	2 x 8" driver with neodymium magnet 1.4" exit compression driver passive crossover network
Connections Y7P	2 x NLT4 F/M optional 2 x NL4
Connections Yi7P	2 x NL4 and screw terminal block
Weight Y7P/Yi7P	18 kg (40 lb)

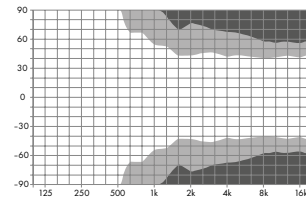

Y7P and Yi7P horizontal dispersion characteristics²

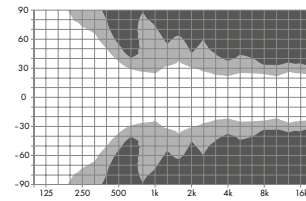

Y7P and Yi7P vertical dispersion characteristics²

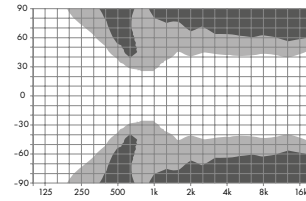

Y7P and Yi7P horizontal dispersion characteristics/horizontal setup, horn rotated²

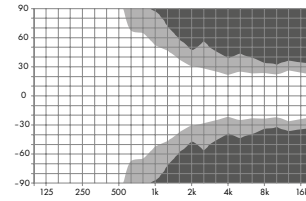

Y7P and Yi7P vertical dispersion characteristics/horizontal setup, horn rotated²

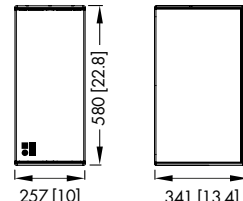

Front view Side view

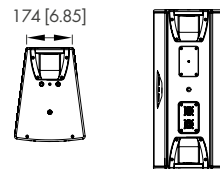

Top view Rear view

Y7P cabinet dimensions in mm [inch]

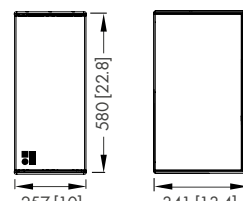

Front view Side view

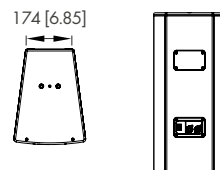

Top view Rear view

Yi7P cabinet dimensions in mm [inch]

¹ Broadband measurement, pink noise, crest factor 4, peak measurement, linear weighting
² Dispersion angle vs frequency plotted using lines of equal sound pressure (isobars) at -6 dB and -12 dB
³ 1 loudspeaker per channel

The Y10P loudspeaker

The Yi10P loudspeaker

Y10P/Yi10P loudspeaker

The compact, 2-way passive Y10P loudspeaker and Yi10P loudspeaker feature two 8" drivers in a dipole arrangement with a 1.4" compression driver mounted onto a rotatable CD horn. The Yi10P is the installation version of the Y10P loudspeaker and differs only in cabinet construction, finish and mounting hardware. Sophisticated horn geometry combined with the advanced bass-reflex port design delivers full bandwidth capabilities with an extended LF output. These point source, high performance cabinets offer 110° horizontal directivity matched with a vertical dispersion of 40°; the horn can be rotated by 90° to enable horizontal orientation.

The Y10P/Yi10P provide a broad variety of deployment possibilities, especially when used as a stand-alone full range system, or combined with other elements from the Y-Series, either ground stacked or flown.

The loudspeaker cabinets are constructed from marine plywood, the Y10P has an impact and weather protected PCP (Polyurea Cabinet Protection) finish, while the Yi10P has an impact resistant paint finish. The front of the loudspeaker cabinets are protected by a rigid metal grill. The Y10P cabinet incorporates a pair of handles whilst M10 threaded inserts are provided for attaching d&b rigging hardware.

System data

Frequency response (-5 dB standard)	59 Hz - 18 kHz
Frequency response (-5 dB CUT mode)	118 Hz - 18 kHz
Max. sound pressure (1 m, free field) ¹	
with D6/10D	131 dB
with 30D/D20	134 dB
with D40/40D ³	136 dB
with D80	136 dB

Loudspeaker data

Nominal impedance	8 ohms
Power handling capacity (RMS/peak 10 ms)	400/1600 W
Nominal dispersion angle (h x v)	110° x 40°
Components	2 x 8" driver with neodymium magnet 1.4" exit compression driver passive crossover network
Connections Y10P	2 x NLT4 F/M optional 2 x NL4
Connections Yi10P	2 x NL4 and screw terminal block
Weight Y10P/Yi10P	18 kg (40 lb)

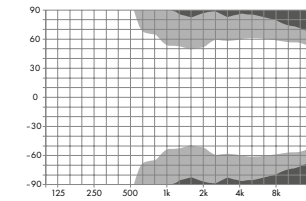

Y10P and Yi10P horizontal dispersion characteristics²

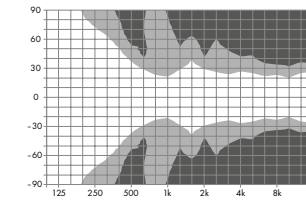

Y10P and Yi10P vertical dispersion characteristics²

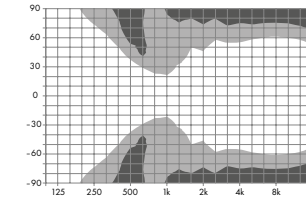

Y10P and Yi10P horizontal dispersion characteristics/horizontal setup, horn rotated²

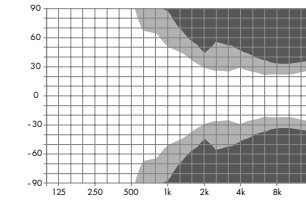

Y10P and Yi10P vertical dispersion characteristics/horizontal setup, horn rotated²

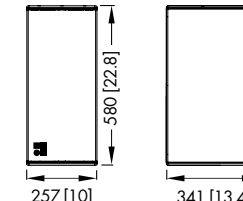

Front view Side view

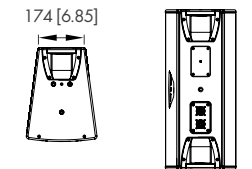

Top view Rear view

Y10P cabinet dimensions in mm [inch]

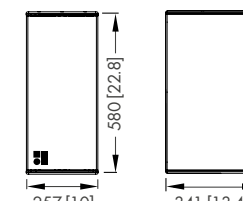

Front view Side view

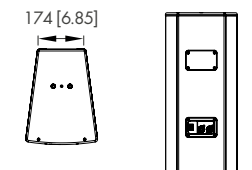

Top view Rear view

Yi10P cabinet dimensions in mm [inch]

¹ Broadband measurement, pink noise, crest factor 4, peak measurement, linear weighting
² Dispersion angle vs frequency plotted using lines of equal sound pressure (isobars) at -6 dB and -12 dB
³ 1 loudspeaker per channel

The B6 subwoofer

The Bi6 subwoofer

The Y7P, Y10P and B6 transport accessories

B6/Bi6 subwoofer

The B6-SUB and Bi6-SUB are high performance subwoofers designed for ground stacked applications, housing a long excursion 18" driver built into a bass-reflex design. The Bi6-SUB is the installation version of the B6 subwoofer and differs only in cabinet construction, finish and mounting hardware. When three or any multiple of three B6 or Bi6 subwoofers are used, they can be positioned in a Cardioid Subwoofer Array, achieving exceptional directivity control in lower frequencies and significantly reducing the energy radiating towards to the rear. The cabinets are constructed from marine plywood, the B6-SUB has an impact and weather protected PCP (Polyurea Cabinet Protection) finish, while the Bi6-SUB has an impact resistant paint finish. The front of the loudspeaker cabinet is protected by a rigid metal grill backed by an acoustically transparent foam. The side panels of the B6-SUB incorporate two handles, whilst four wheels are mounted to the rear and the enclosure features two runners to protect the bottom panel from scratching. Two correspondingly shaped recesses are incorporated into the top panel of each B6-SUB cabinet to accept these runners, preventing cabinet movement when stacked. An M20 threaded flange in the top panel accepts the d&b Loudspeaker stand winder M20.

System data

Frequency response (-5 dB standard).....37 Hz - 140 Hz
 Frequency response (-5 dB 100 Hz mode).....37 Hz - 110 Hz
 Max. sound pressure (1 m, free field)¹
 with D6/10D 128 dB
 with 30D/D20 131 dB
 with D40/40D² 134 dB
 with D80 134 dB

Loudspeaker data

Nominal impedance..... 8 ohms
 Power handling capacity (RMS/peak 10 msec)500/2000 W
 Components..... 1 x 18" driver
 Connections B6 2 x NLT4 F/M
 optional 2 x NL4
 Connections Bi6..... 2 x NL4 and screw terminal block
 Weight B6/Bi6 41/38 kg (90/84 lb)

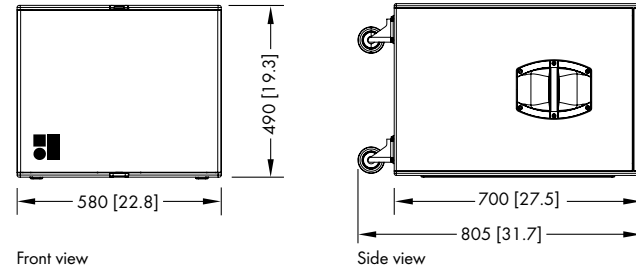

Front view

Side view

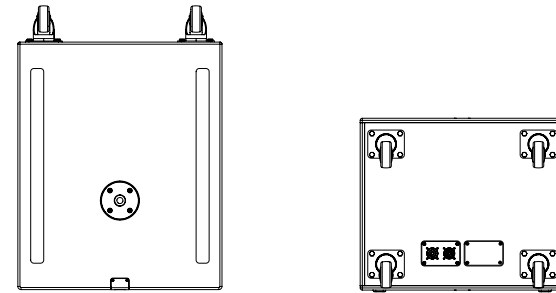

Top view

Rear view

B6-SUB cabinet dimensions in mm [inch]

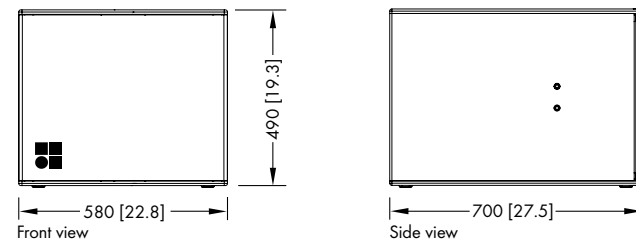

Front view

Side view

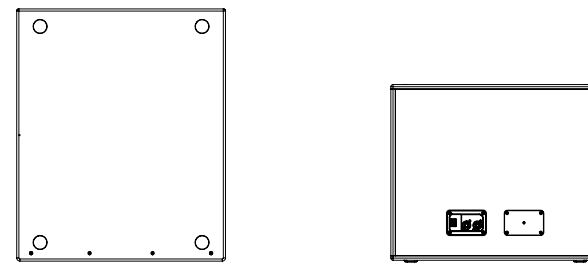

Top view

Rear view

Bi6-SUB cabinet dimensions in mm [inch]

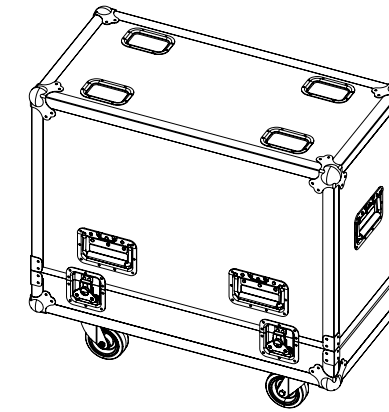

E7473
Touring case 2 x Y7P/Y10P
 Dimensions (H x W x D):
 775 x 812 x 417 mm
 30.5 x 32 x 16.4 inch
 Net weight: 38 kg (84 lb)

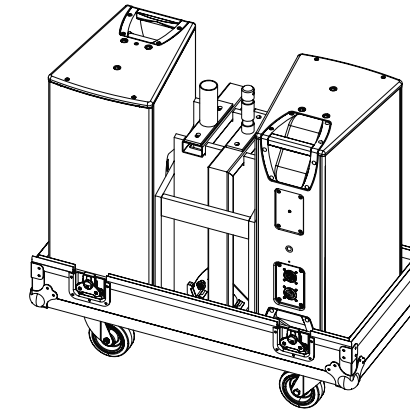

E7925
B6-SUB Transport lid

¹ Broadband measurement, pink noise, crest factor 4, peak measurement, linear weighting
² 1 subwoofer per channel

The Y8 loudspeaker

The Yi8 loudspeaker

Y8/Yi8 loudspeaker

The compact Y8 and Yi8 line array loudspeakers are designed for use in vertical columns. The 2-way passive design features two 8" drivers in a dipole arrangement and a centrally mounted 1.4" compression driver with a wave transformer. The Yi8 is the installation version of the Y8 loudspeaker and differs only in cabinet construction, finish and mounting hardware. Sophisticated horn geometry combined with the advanced bass-reflex port design delivers full bandwidth capabilities with an extended LF output. These high performance line array modules offer 80° horizontal directivity controlled down to 500 Hz.

The mechanical and acoustical design enables vertical arrays of up to twenty four loudspeakers with vertical splay angles from 0° to 14° with a 1° resolution. It can be used in columns of purely Y8 loudspeaker or Yi8 loudspeaker or combined with Y12/Yi12 and/or Y-SUB/Yi-SUB cabinets.

The loudspeaker cabinets are constructed from marine plywood, the Y8 has an impact and weather protected PCP (Polyurea Cabinet Protection) finish, while the Yi8 has an impact resistant paint finish. The front of the loudspeaker cabinet is protected by a rigid metal grill backed by an acoustically transparent foam. Each side panel of the Y8 incorporates a handle while two additional recessed grips are provided at the rear. Three point rigging hardware is integrated into the loudspeaker enclosure.

System data

Frequency response (-5 dB standard)	54 Hz - 19 kHz
Frequency response (-5 dB CUT mode)	100 Hz - 19 kHz
Max. sound pressure (1 m, free field) ¹	
with D6/10D	134 dB
with 30D/D20	137 dB
with D40/40D ³	139 dB
with D80	139 dB

Loudspeaker data

Nominal impedance	8 ohms
Power handling capacity (RMS/peak 10 ms)	400/1600 W
Nominal dispersion angle (h)	80°
Splay angle settings	0° - 14° (1° increment)
Components	2 x 8" driver with neodymium magnet 1.4" exit compression driver passive crossover network
Connections Y8	2 x NLT4 F/M
Connections Yi8	optional 2 x NL4
Weight Y8/Yi8	20 kg (44 lb)

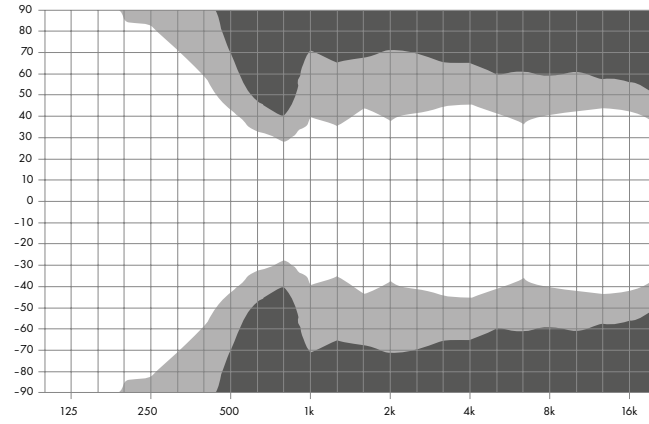

Y8 and Yi8 horizontal dispersion characteristics²

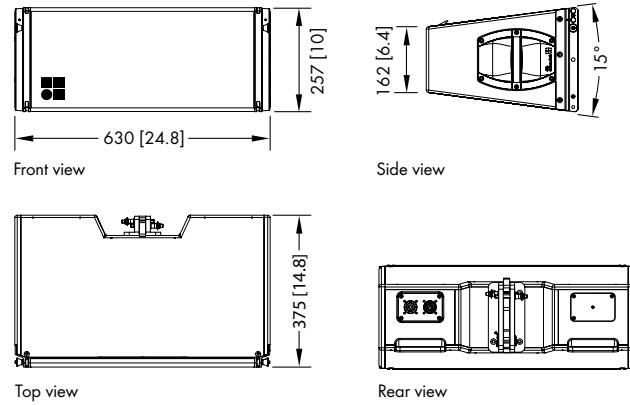

Y8 cabinet dimensions in mm [inch]

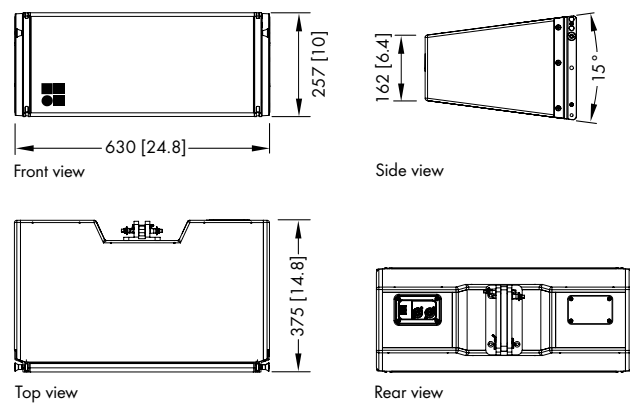

Yi8 cabinet dimensions in mm [inch]

¹ Broadband measurement, pink noise, crest factor 4, peak measurement, linear weighting
² Dispersion angle vs frequency plotted using lines of equal sound pressure (isobars) at -6 dB and -12 dB
³ 1 loudspeaker per channel

The Y12 loudspeaker

The Yi12 loudspeaker

Y12/Yi12 loudspeaker

The compact Y12 and Yi12 line array loudspeakers are designed for use in vertical columns. The 2-way passive design features two 8" drivers in a dipole arrangement and a centrally mounted 1.4" compression driver with a wave transformer. The Yi12 is the installation version of the Y12 loudspeaker and differs only in cabinet construction, finish and mounting hardware. Sophisticated horn geometry combined with the advanced bass-reflex port design delivers full bandwidth capabilities with an extended LF output. These high performance line array modules offer 120° horizontal directivity controlled down to 500 Hz.

The mechanical and acoustical design enables vertical arrays of up to twenty four loudspeakers with vertical splay angles from 0° to 14° with a 1° resolution. It can be used in columns of purely Y12 loudspeaker or Yi12 loudspeaker or combined with Y8/Yi8 and/or Y-SUB/Yi-SUB cabinets.

The loudspeaker cabinets are constructed from marine plywood, the Y12 has an impact and weather protected PCP (Polyurea Cabinet Protection) finish, while the Yi12 has an impact resistant paint finish. The front of the loudspeaker cabinet is protected by a rigid metal grill backed by an acoustically transparent foam. Each side panel of the Y12 incorporates a handle while two additional recessed grips are provided at the rear. Three point rigging hardware is integrated into the loudspeaker enclosure.

System data

Frequency response (-5 dB standard)	54 Hz - 19 kHz
Frequency response (-5 dB CUT mode)	100 Hz - 19 kHz
Max. sound pressure (1 m, free field) ¹	
with D6/10D	134 dB
with 30D/D20	137 dB
with D40/40D ³	139 dB
with D80	139 dB

Loudspeaker data

Nominal impedance	8 ohms
Power handling capacity (RMS/peak 10 ms)	400/1600 W
Nominal dispersion angle (h)	120°
Splay angle settings	0° - 14° (1° increment)
Components	2 x 8" driver with neodymium magnet 1.4" exit compression driver passive crossover network
Connections Y12	2 x NLT4 F/M
Connections Yi12	optional 2 x NL4
Weight Y12/Yi12	20 kg (44 lb)

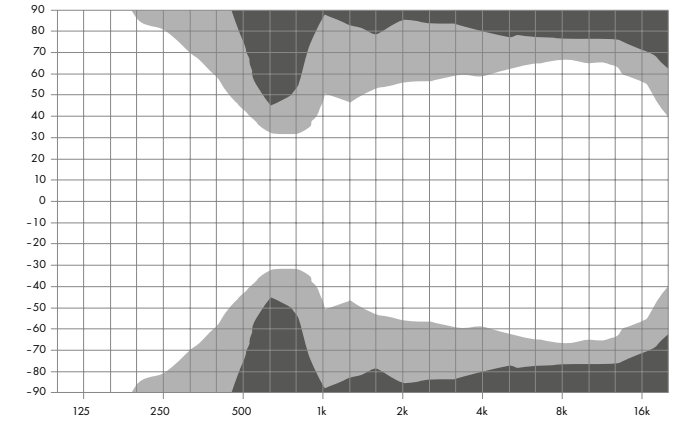

Y12 and Yi12 horizontal dispersion characteristics²

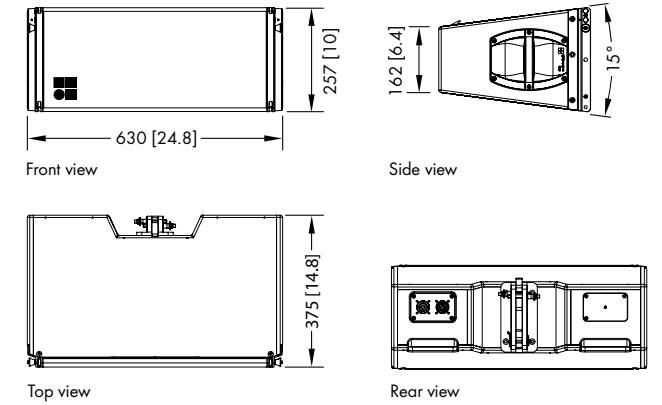

Y12 cabinet dimensions in mm [inch]

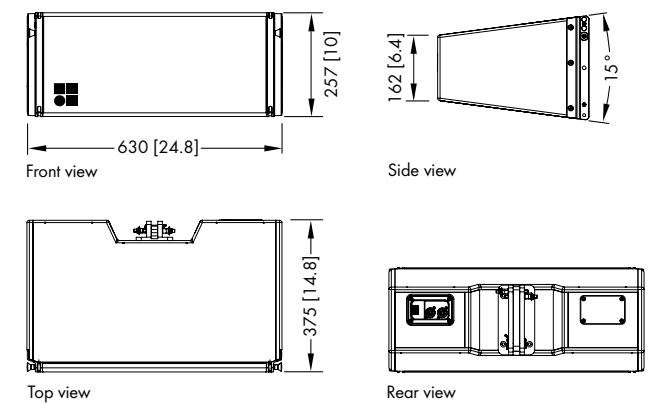

Yi12 cabinet dimensions in mm [inch]

¹ Broadband measurement, pink noise, crest factor 4, peak measurement, linear weighting
² Dispersion angle vs frequency plotted using lines of equal sound pressure (isobars) at -6 dB and -12 dB
³ 1 loudspeaker per channel

The Y subwoofer

The Yi subwoofer

Y/Yi subwoofer

The Y-SUB and Yi-SUB are actively driven cardioid subwoofers powered by a single amplifier channel. The Yi-SUB is the installation version of the Y-SUB and differs only in cabinet construction, finish and mounting hardware. They house two long excursion neodymium drivers in an integrated cardioid setup, an 18" driver in a bass-reflex chamber facing to the front and a 12" driver in a two chamber bandpass design radiating towards the rear.

The cardioid dispersion pattern resulting from this arrangement avoids the distribution of energy behind the system, providing the greatest accuracy of low frequency reproduction and reducing the energy dispersed into unwanted areas. The Y-SUB and Yi-SUB are fitted with three point rigging hardware and can be flown in columns of purely Y or Yi subwoofers, at the top of a Y/Yi array or used in a ground stacked setup.

The cabinets are constructed from marine plywood, the Y-SUB has an impact and weather protected PCP (Polyurea Cabinet Protection) finish while the Yi-SUB has an impact resistant paint finish. The front of the loudspeaker cabinet is protected by a rigid metal grill backed by an acoustically transparent foam, whilst the side panels of the Y-SUB incorporate four handles with four wheels mounted to the rear.

System data

Frequency response (-5 dB standard)	39 Hz - 140 Hz
Frequency response (-5 dB 100 Hz mode)	39 Hz - 110 Hz
Max. sound pressure (1 m, free field) ¹	
with D6/10D	128 dB
with 30D/D20	131 dB
with D40/40D ²	134 dB
with D80	134 dB

Loudspeaker data

Nominal impedance	8 ohms
Power handling capacity (RMS/peak 10 ms)	600/2400 W
Splay angle settings	0° and 2.5°
Components	1x 18" driver with neodymium magnet
.....	1x 12" driver with neodymium magnet
Connections Y-SUB	2 x NLT4 F/M
.....	optional 2 x NL4
Connections Yi-SUB	2 x NL4 and screw terminal block
Weight Y-SUB/Yi-SUB	52/49 kg (115/108 lb)

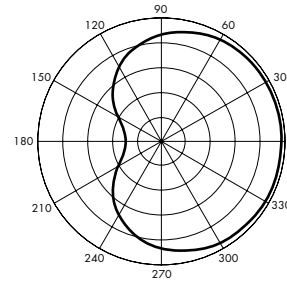

Cardioid polar pattern

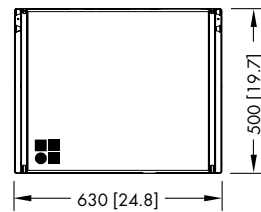

Front view

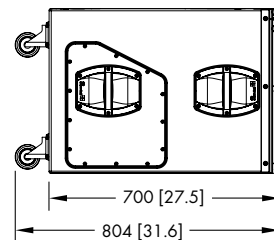

Side view

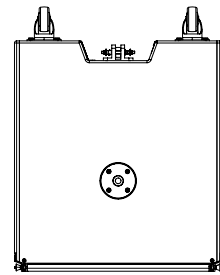

Top view

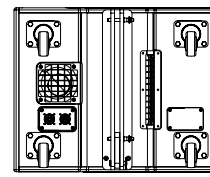

Rear view

Y-SUB cabinet dimensions in mm [inch]

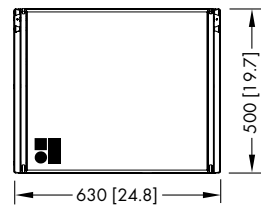

Front view

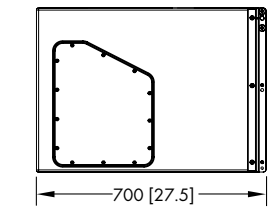

Side view

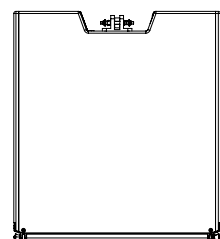

Top view

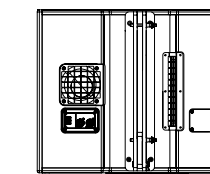

Rear view

Yi-SUB cabinet dimensions in mm [inch]

The Y8, Y12 and Y-SUB transport accessories

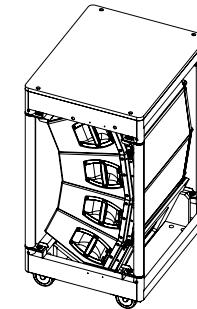

E7470
Touring cart 4 x Y8/Y12
Dimensions (H x W x D):
1200 x 600 x 730 mm
47.3 x 23.7 x 29 inch
Total weight: 130 kg (285 lb)
Max. top load: 100 kg (220 lb)

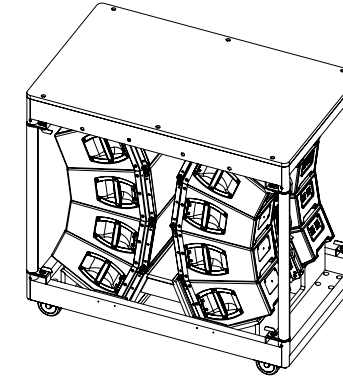

E7471
Touring cart 8 x Y8/Y12
Dimensions (H x W x D):
1200 x 1200 x 730 mm
47.3 x 47.3 x 29 inch
Total weight: 230 kg (510 lb)
Max. top load: 200 kg (440 lb)

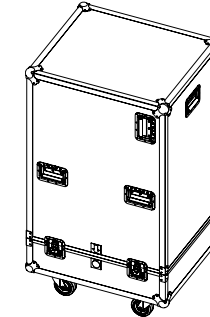

E7472
Touring case 4 x Y8/Y12
Dimensions (H x W x D):
1271 x 724 x 626 mm
50 x 28.5 x 24.6 inch
Net weight: 61 kg (135 lb)

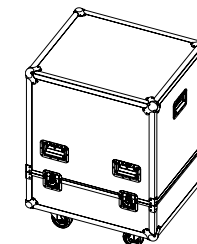
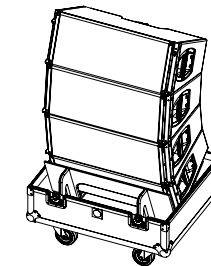

E7475
Touring case 2 x Y Flying frame
Dimensions (H x W x D):
962 x 724 x 628 mm
38 x 28.5 x 24.7 inch
Net weight: 51 kg (112 lb)

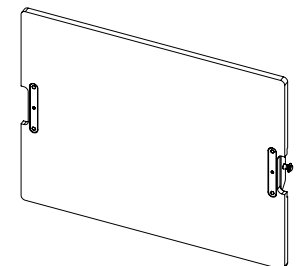

E7924
Y-SUB Transport lid

¹ Broadband measurement, pink noise, crest factor 4, peak measurement, linear weighting
² 1 loudspeaker per channel

The Y7P, Y10P and B6-SUB mounting accessories

The Y7P, Y10P and B6-SUB mounting examples

Safety approval

d&b loudspeakers and accessories are designed for setup and use within situations requiring compliance with the provisions and directives of the DGUV regulation 17 (formerly BGV C1).

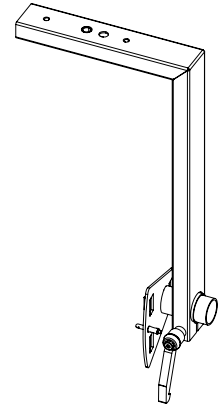

Z5397
YP Swivel bracket

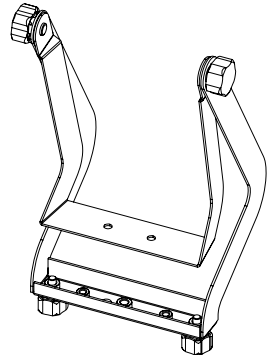

Z5399
YP Mounting bracket

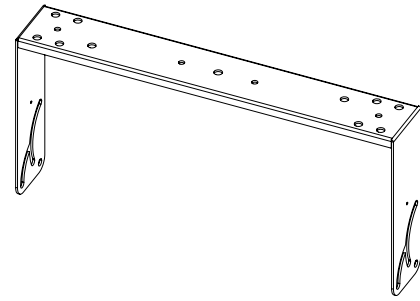

Z5398
YP Horizontal bracket

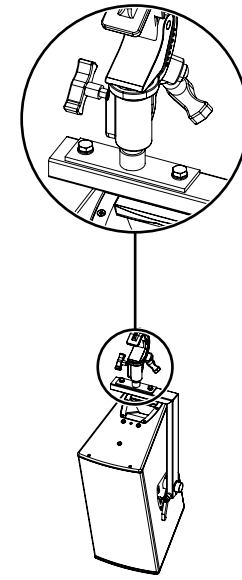

Y7P/Y10P with
Z5397 YP Swivel bracket
Z5010 TV Spigot with fixing plate
Z5012 Pipe clamp

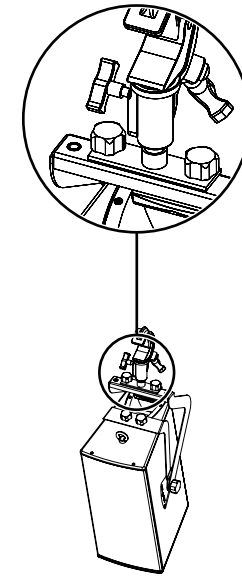

Y7P/Y10P with
Z5399 YP Mounting bracket
Z5010 TV Spigot with fixing plate
Z5012 Pipe clamp

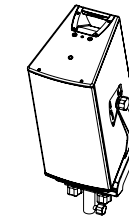

Y7P/Y10P with
Z5399 YP Mounting bracket
Z5024 Loudspeaker
stand adapter

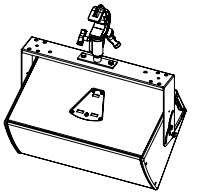

Y7P/Y10P with
Z5398 YP Horizontal bracket
Z5010 TV Spigot with fixing plate
Z5012 Pipe clamp

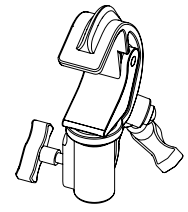

Z5012
Pipe clamp for TV Spigot
For a tube diameter up to
70 mm/2.75"

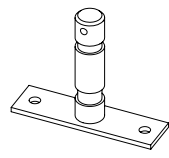

Z5010
TV Spigot with fixing plate

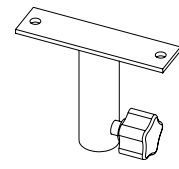

Z5024
Loudspeaker stand adapter

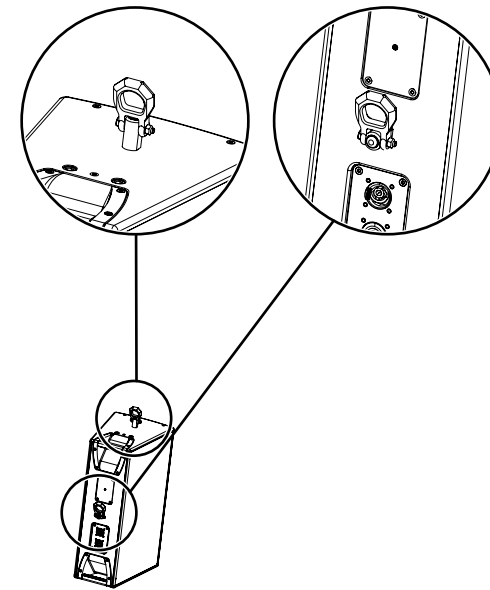

Y7P/Y10P with
2 x Z5049 Flying pin 8mm

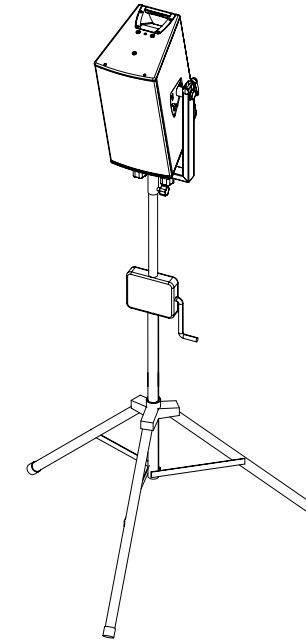

Y7P/Y10P with
Z5397 YP Swivel bracket
Z5009 Loudspeaker stand with winder
Z5024 Loudspeaker stand adapter

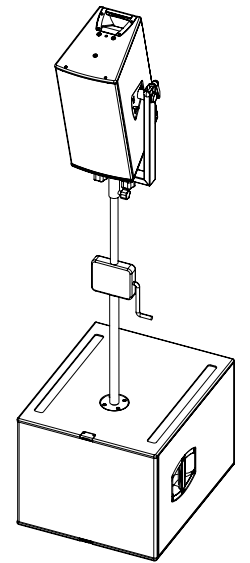

Y7P/Y10P with
Z5397 YP Swivel bracket
Z5013 M20 pole with winder
Z5024 Loudspeaker stand adapter



Z5049
Flying pin 8mm¹

The Yi7P, Yi10P and Bi6-SUB mounting accessories

The Yi7P, Yi10P and Bi6-SUB mounting examples

Safety approval

d&b loudspeakers and accessories are designed for setup and use within situations requiring compliance with the provisions and directives of the DGUV regulation 17 (formerly BGV C1).

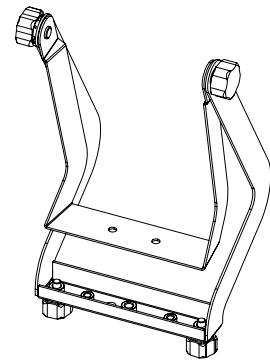

Z5399
YP Mounting bracket

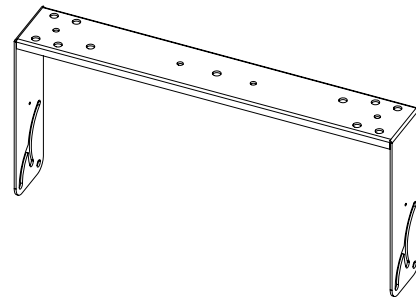

Z5398
YP Horizontal bracket

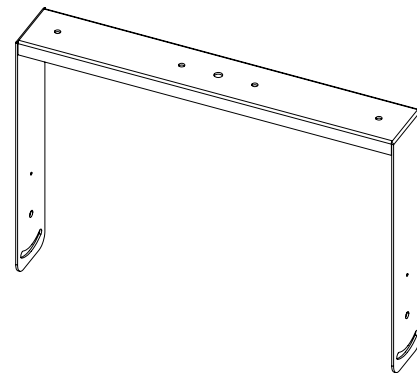

Z5389
Bi6-SUB Horizontal bracket

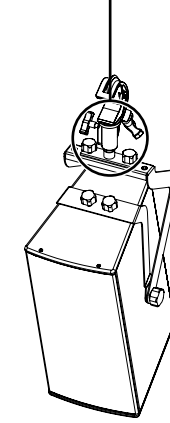
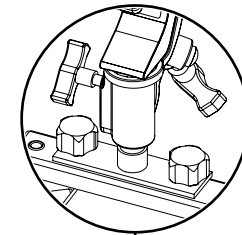

Yi7P/Yi10P with
Z5399 YP Mounting bracket
Z5010 TV Spigot with fixing plate
Z5012 Pipe clamp

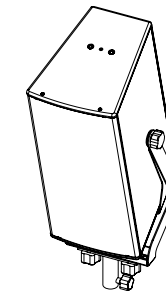

Yi7P/Yi10P with
Z5399 YP Mounting bracket
Z5024 Loudspeaker stand adapter

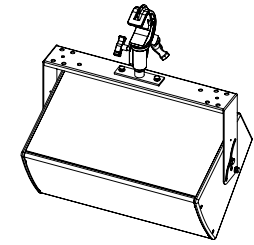

Yi7P/Yi10P with
Z5398 YP Horizontal bracket
Z5010 TV Spigot with fixing plate
Z5012 Pipe clamp

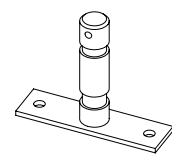

Z5010
TV Spigot with fixing plate

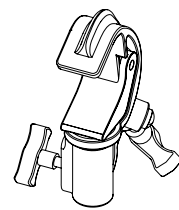

Z5012
Pipe clamp for TV Spigot
For a tube diameter up to
70 mm/2.75"

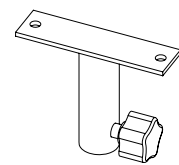

Z5024
Loudspeaker stand adapter

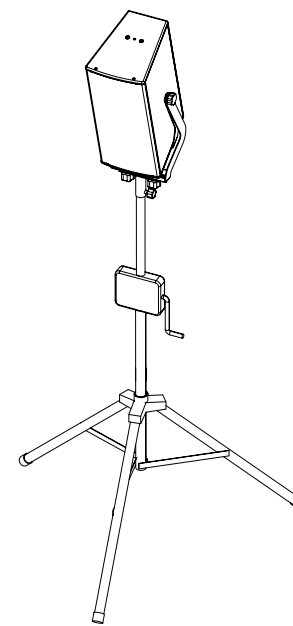

Yi7P/Yi10P with
Z5399 YP Mounting bracket
Z5009 Loudspeaker stand with winder

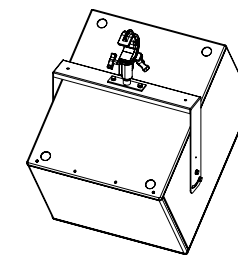

Bi6-SUB with
Z5389 Bi6 Horizontal bracket
Z5010 TV Spigot with fixing plate
Z5012 Pipe clamp

The Y8/Yi8, Y12/Yi12 and Y/Yi-SUB rigging accessories

The Y8, Y12 and Y-SUB rigging examples

Safety approval

d&b loudspeakers and accessories are designed for setup and use within situations requiring compliance with the provisions and directives of the DGUV regulation 17 (formerly BGV C1).

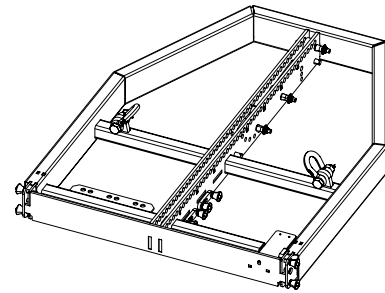

**Z5390
Y Flying frame**
For a maximum of twenty four Y8/Y12/Yi8/Yi12 loudspeakers or ten Y/Yi subwoofers

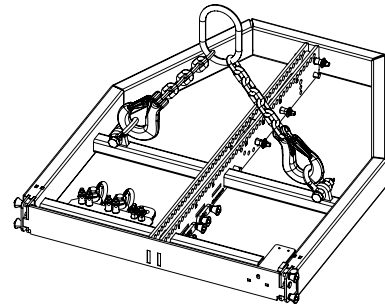

**Z5390
Y Flying frame**
Supplied with
1 x Z5392 Y Safety chainset
2 x Y Load adapter
1 x Y Load adapter for rota clamp
2 x Front link

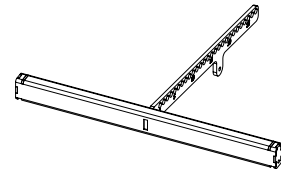

**Z5394
Y Flying adapter**
For a maximum of six Y8/Y12 loudspeakers; supplied with 1t Shackle

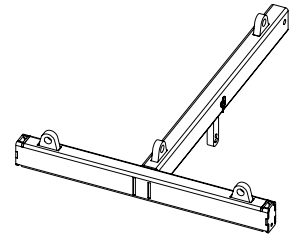

**Z5393.000
Yi Mounting frame top**
For a maximum load equivalent to six Yi8/Yi12 loudspeakers

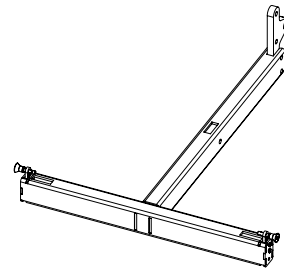

**Z5393.001
Yi Mounting frame bottom**

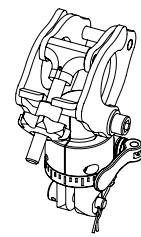

**Z5147
Rota clamp**
WLL: 500 kg (1100 lb) for a tube diameter up to 51 mm/2"

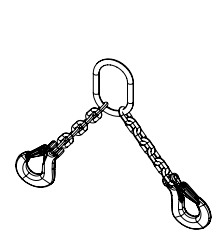

**Z5392
Y Safety chainset**



**Z5391
Y Hoist connector chain**



**E6507
1t Shackle**

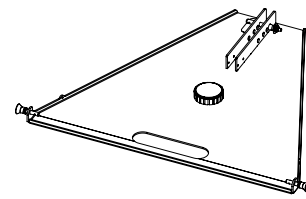

**Z5396
Y Base plate**

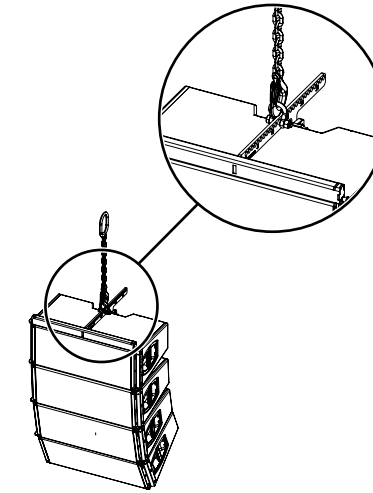

**Y8/Y12 array with
Z5394 Y Flying adapter
Z5391 Y Hoist connector chain**

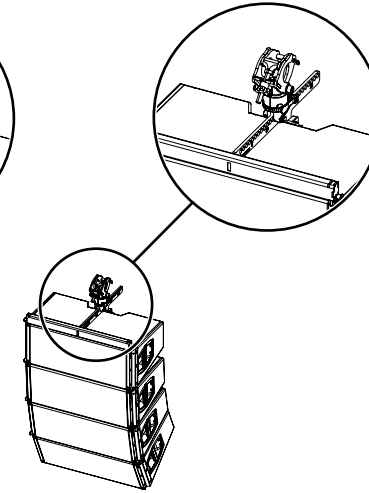

**Y8/Y12 array with
Z5394 Y Flying adapter
Z5147 Rota clamp**

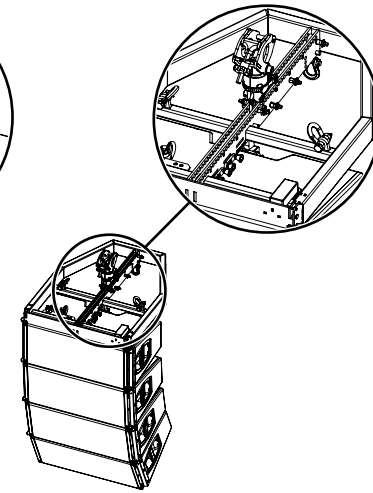

**Y8/Y12 array with
Z5390 Y Flying frame
Z5147 Rota clamp**

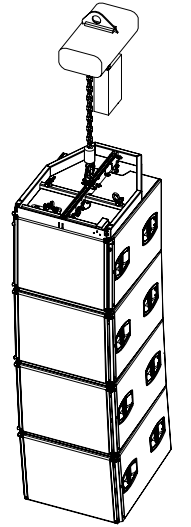

**Y-SUB column with
Z5390 Y Flying frame**

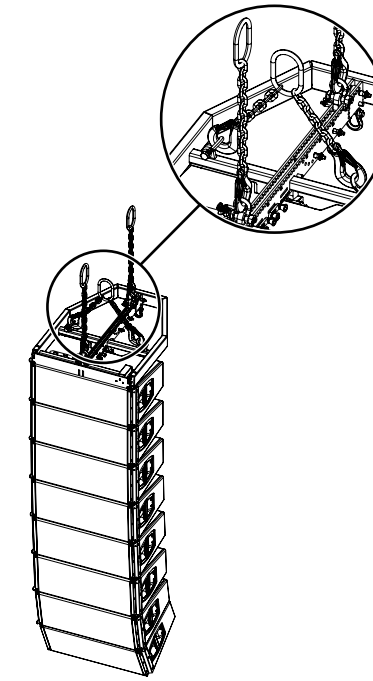

**Y8/Y12 array with
Z5390 Y Flying frame
2 x Z5391 Y Hoist connector chain
Z5392 Y Safety chainset**

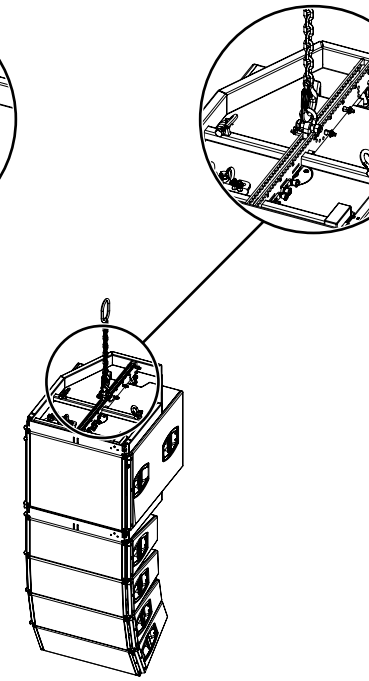

**Y-Series array with
Z5390 Y Flying frame
Z5391 Y Hoist connector chain**

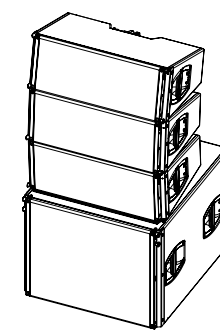

**Y-Series ground stack with
Z5396 Y Base plate**

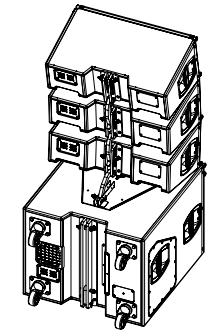

The Yi8, Yi12 and Yi-SUB rigging examples

Safety approval

d&b loudspeakers and accessories are designed for setup and use within situations requiring compliance with the provisions and directives of the DGUV regulation 17 (formerly BGV C1).

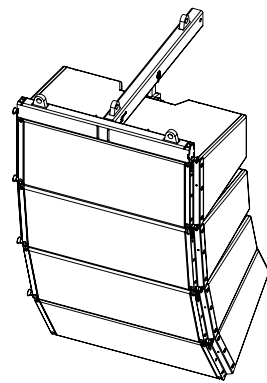

Yi8/Yi12 array with
Z5393.000 Yi Mounting frame top

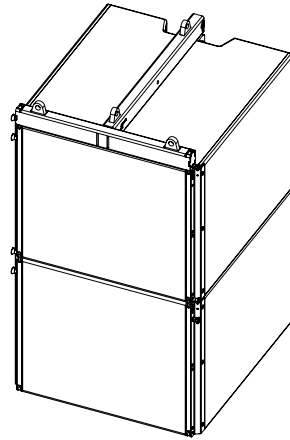

Yi-SUB column with
Z5393.000 Yi Mounting frame top

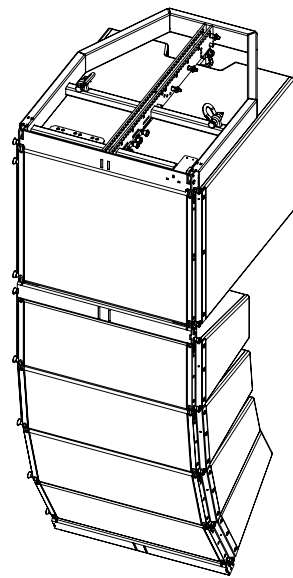

Yi array with
Z5390 Y Flying frame
2 x Z5393.001 Yi Mounting frame bottom

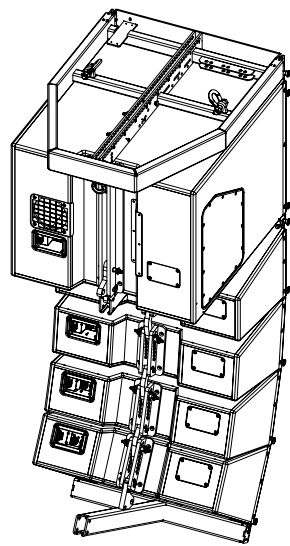

The Yi Weather Resistant, Special Colour and Custom solutions options

Weather Resistant (WR) option

The WR option provides an IP54 rating, and enables operation of loudspeakers in changing ambient conditions, with some loudspeakers able to achieve an IP55 rating. However it is not intended to enable permanent, unprotected operation of loudspeakers outdoors. Cabinets used outdoors even with the WR option should always be aimed either horizontally or with a downward tilt. All WR speakers will be delivered without a cable. An optional WR cable (Z5763.000 - H07-RN-F 2 x 2.5 mm² / AWG 13, Faston connector type 2 x 6.3 mm male) with a standard length of 5.5 m is available. Other length on request.

Special Colour (SC) option

The paint finish of all loudspeaker cabinets and most accessories can be executed in almost any custom colour in accordance with common colour tables. All rigging fittings at the rear of the cabinet, Front links and Locking pins remain in black. Other paint finishes such as metallic are available on request. The acoustically transparent foam fitted behind the rigid metal grill is also painted with the requested special colour.

Custom solutions (SVS and SWR) option

SVS (Variants For Stadiums) loudspeakers have no integral rigging components, but instead, have threaded inserts in their side panels. The cabinets will be mechanically supported by metal brackets specifically designed for the respective application by Custom solutions.

SWR (Sea Water Resistant) loudspeaker models are based on WR or SVS variants where available, and withstand outdoor operation in wet and acid or salty environments like on cruise ships or coastal locations. Other custom solutions are available upon request.

The d&b ArrayCalc simulation software

The d&b ArrayCalc simulation software is the prediction tool for d&b line arrays, column and point source loudspeakers as well as subwoofers. This is a comprehensive toolbox for all tasks associated with acoustic design, performance prediction, alignment, rigging and safety parameters. For safety reasons d&b line arrays must be designed using the d&b ArrayCalc simulation software. ArrayCalc is available as a native stand-alone application for both Microsoft Windows¹ (Win7 64-bit or later) and Mac OS X² (10.12 or later) operating systems. In combination with the d&b Remote Network, this can significantly reduce setup and tuning time in mobile applications and allows for precise simulations when planning installations. Listening planes can be defined in the venue tab, creating a three dimensional representation of any audience area in a given venue. This can also include balconies, side stalls, arenas, in the round scenarios or festivals. Special functions assist in obtaining accurate dimensions with laser distance finders and inclinometers.

Simulation

Up to forty flown arrays or subwoofer columns can be defined in a project file as single hangs or in pairs. A selection of d&b point source loudspeakers can also be fully integrated as well as a ground stacked SUB array consisting of up to eighty positions. All can be freely positioned according to their intended application, for example as main hang, outfill, nearfill or delay. Position, orientation, aiming and coverage details are displayed. Level over distance is calculated for each source with high resolution in real time, for either band limited or broadband input signals. The comprehensive simulation precisely models the actual performance of the system, taking into account input level, all system configuration options (such as CUT, CPL, HFC or INFRA), limiter headroom and air absorption. Acoustic obstacles, such as video screens, can be added to a model. Acoustic shadowing, whether by these obstacles, or a balcony overhang, is taken into consideration. The load status of all array rigging components is calculated accurately and displayed to determine whether a given array is within the load tolerance. Subwoofer array design is assisted by coverage and polar plot prediction. A specialized algorithm allows the user to specify subwoofer positions and a coverage angle, which is then converted into appropriate delay settings that result in the desired dispersion. The alignment tab enables different sources to be time aligned to one another, as well as showing arrival times and Sound Pressure Levels at a definable reference point on one of the audience areas. For alignment of the flown system with the ground stacked SUB array, the phase response of both the SUB array and a flown source is calculated at a definable reference point.

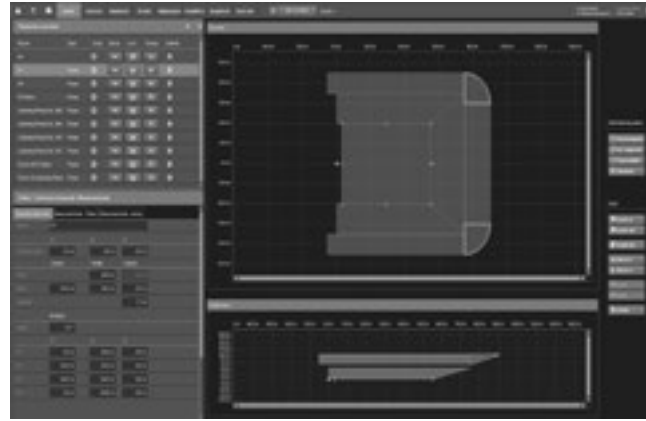

Venue

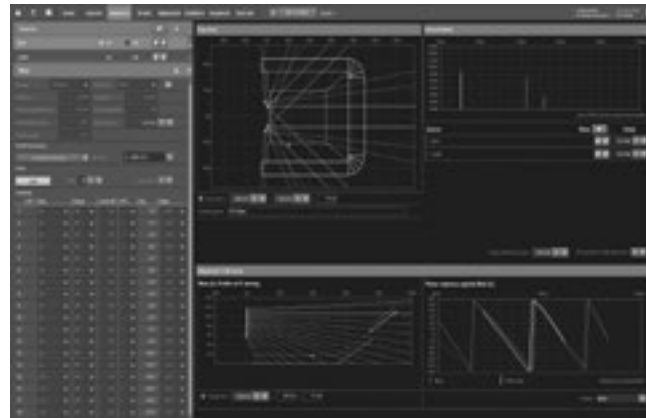

Alignment

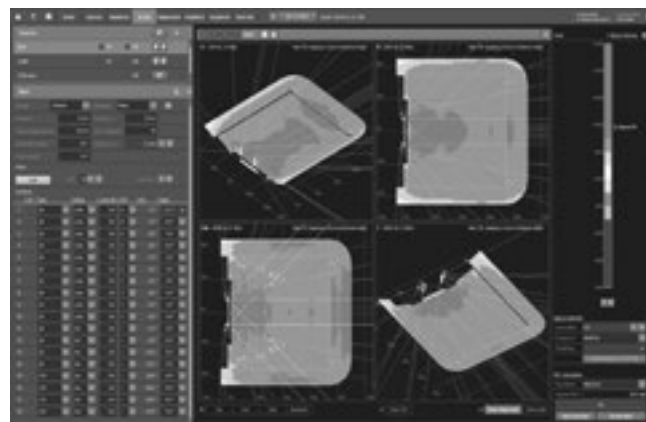

3D Plot quad

Both simulations reflect changes in delay time to the single sources in real time. The d&b ArrayCalc simulation software is available at www.dbaudio.com.

Prediction

The level distribution resulting from the interaction of all active sources can be mapped onto the audience areas in a three-dimensional view, which can also be zoomed, rotated and exported as a graphics file. EASE and DXF data export capabilities are also available. A rigging plot with all necessary coordinates, dimensions and weights of arrays is generated for export and printing and a parts list, detailing all components required. The d&b ArrayCalc Viewer app presents this key information for positioning and flying a d&b audiotechnik loudspeaker system on a mobile device. Once the system has been designed, calculated and optimized, all relevant project information can be shared via email, AirDrop, or downloaded onto any iOS or Android device.

ArrayProcessing

The optional ArrayProcessing function applies powerful filter algorithms to optimize the tonal (spectral) and level (spatial) performance of a line array column over the audience area defined by its mechanical vertical coverage angle. Temperature and Humidity Control (THC) for ArrayProcessing introduces a workflow that permits a system to adapt to changing atmospheric conditions in real time via R1. Within the d&b ArrayCalc simulation software, spectral and level performance targets over the listening areas can be defined while specific level drops or offsets can be applied to certain areas, to assign reduced level zones. ArrayProcessing applies a combination of FIR and IIR filters to each individual cabinet in an array to achieve the targeted performance, with an additional latency of only 5.9 ms. This significantly improves the linearity of the response over distance as well as seamlessly correcting for air absorption. In addition, ArrayProcessing employs the same frequency response targets for all d&b line arrays, to ensure all systems share a common tonality. The resulting coverage is enhanced with spectral consistency and defined level distribution, achieving more linear dispersion and total system directivity to cover longer distances or steep listening areas effectively.

R1 Remote Control Software

R1 uses the same project file created by ArrayCalc and generates an intuitive graphical user interface including complete details of the simulated system, loudspeakers, amplifiers, remote IDs, groups, ArrayProcessing data and all configuration information. This workflow removes the need to manually transfer data from one software program to the other.

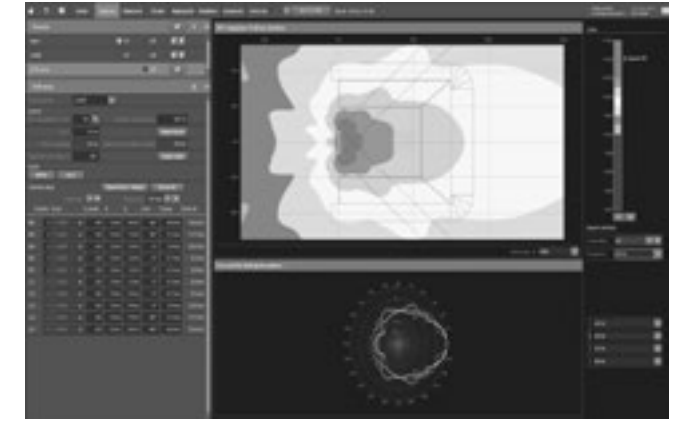

Sources, SUB array

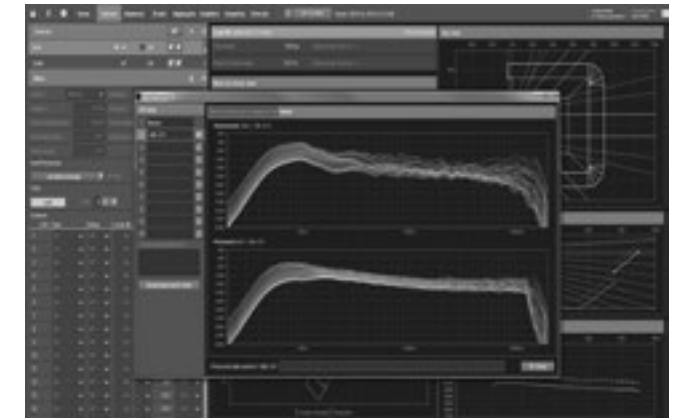

ArrayProcessing



Amplifiers

¹ Microsoft Windows is a registered trademark or trademark of Microsoft Corporation in the United States and/or other countries

² Mac OS X is a trademark of Apple Inc., registered in the U.S. and other countries

The d&b NoizCalc immission modelling software

The d&b software uses international standards to model the far field noise immission from multiple complex and coherently emitting sources such as line arrays and subwoofer arrays. More and more, gaining permission and licenses to stage live open air events requires an official statement with a prediction of how noise could impact on the surrounding area. NoizCalc takes all complex loudspeaker data and a reference point from the d&b ArrayCalc simulation software and calculates the sound propagation and relative attenuation values towards the far field for a certain scenario with particular meteorological conditions for one or more d&b loudspeaker systems.

A 3D terrain map imported from Google Maps or Street View displays the calculated immission on the areas surrounding the audience listening zones. This visual representation shows the actual system performance in the far field, enabling users to optimize for listeners while satisfying local noise restrictions and offsite regulations.

To ensure reliable results, NoizCalc includes all complex data concerning the addition and subtraction of sound waves, including phase information to describe the combination and interaction effects within a loudspeaker system consisting of multiple line arrays, subwoofer arrays and delay systems.

NoizCalc models immissions in the far field according to the internationally accepted ISO 9613-2 or Nord2000 calculation standards. Ground characteristics can be set depending on the absorbency or reflectivity of surfaces, while areas with volume attenuating properties can be defined. Buildings can be included, and the maximum reflection order option adjusts how many reflections are calculated. Parameters for humidity, air pressure and temperature ensure that the correct air absorption figures are accounted. The ISO 9613-2 standard requires limited meteorological information and assumes a worst-case scenario. The more sophisticated propagation model, Nord2000 enables a more precise handling of meteorological conditions allowing the user to model with prevailing wind information. The d&b NoizCalc immission modelling software is available at www.dbaudio.com for registered download, along with further information and video tutorials. It was developed in collaboration with SoundPLAN, a specialist software developer for environmental noise prediction.

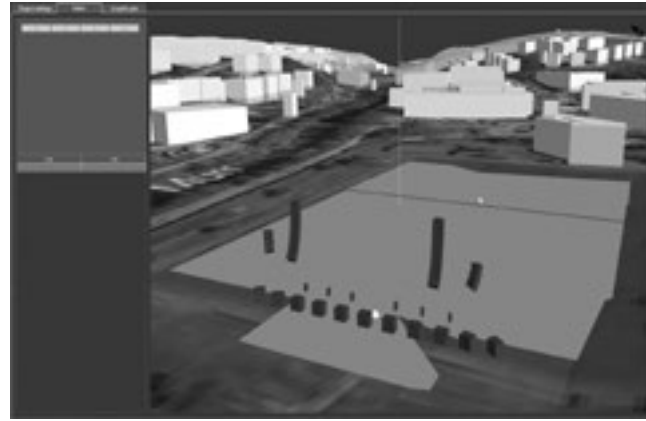

Editor



Graphic plot

The d&b Remote network

The remote control capability of the d&b Remote Network enables central control and monitoring of a complete d&b loudspeaker system from anywhere in the network, be it from a computer in the control room, at the mix position, or on a wireless tablet in the auditorium. This central access to all functions throughout the d&b Remote Network unlocks the full potential of the d&b system approach. In a typical user workflow, the d&b Remote Network takes settings optimized in the d&b ArrayCalc simulation software and applies these to all the amplifiers within the network.

All functions and controls available on the front panel of d&b amplifiers may be remotely controlled and/or monitored using the d&b R1 Remote control software. This allows each channel of the amplifier to be controlled and enables the creation of groups of loudspeakers. When grouped together, a button or fader can control the overall system level, zone level, equalization and delay, power ON/OFF, MUTE, as well as loudspeaker specific function switches such as CUT/HFA/HFC and CPL. An offline mode is provided for preparation in advance of an event, without the amplifiers being present or connected.

d&b System check verifies that the system performs within a predefined condition, while the Array verification function automatically identifies the physical position of a loudspeaker in an array to check that the system is cabled correctly. Extensive facilities for storing and recalling system settings are provided allowing these to be repeated, as and when required. For mobile applications, project files can be easily adjusted for use with a different set of equipment at another location.

The R1 software is optimized for use with touch screen, mouse and keyboard and runs on both Microsoft Windows¹ (Win7 64-bit or later) and Mac OS X² (10.12 or later).

In installation projects the R90 Touchscreen remote control can be used for quick and reliable operation of day-to-day functions of a pre-configured d&b system without needing expert level knowledge of audio. The built-in 7" panel PC provides users with one-touch control over power, mute, level, grouping and recall of up to nine AmpPresets, entirely independent of R1.

Further information is provided at www.dbaudio.com.



R1 home screen



R1 in configuration mode

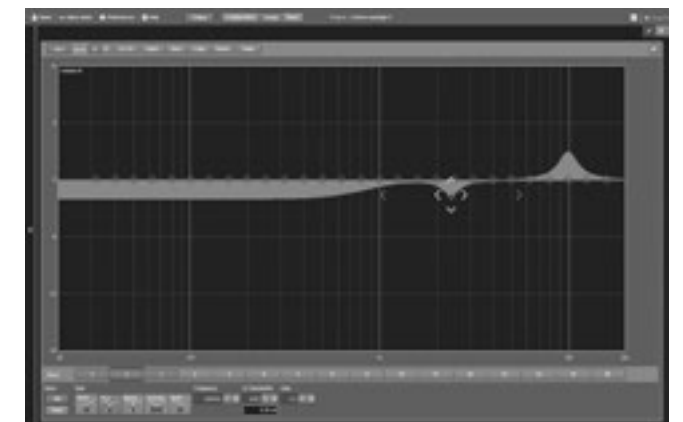

D20/D80 16-band equalizer in R1

¹ Microsoft Windows is a registered trademark or trademark of Microsoft Corporation in the United States and/or other countries

² Mac OS X is a trademark of Apple Inc., registered in the U.S. and other countries

The d&b amplifiers

The d&b amplifiers are designed specifically to power d&b loudspeakers and are the beating heart of the d&b System reality. As such, they incorporate Digital Signal Processing for comprehensive loudspeaker management, switchable filter functions, remote capabilities and user-definable controls, to fulfil the exact needs of each application. Every loudspeaker configuration combines comprehensive system limiting, and equalization and crossover settings to ensure consistent results and optimal performance. d&b amplifiers offer

different output configurations for different loudspeaker setups, including Dual Channel mode, for passive setups, Mix TOP/SUB mode, in which two channels are driven through a single output connector, and 2-Way Active mode, which also sends the output of two channels down one connector to drive appropriate loudspeakers actively. The d&b switch functions provide selected filters to precisely tailor a wide variety of setups to their applications. Examples of these switch functions are the CSA (Cardioid Subwoofer Array)

and HFC (High Frequency Compensation) modes. CSA increases low frequency directivity control by minimising energy transmission towards the rear while HFC compensates for air absorption for loudspeakers covering far field listening positions. In addition to these functions, d&b amplifiers offer a comprehensive set of specific filters such as CUT, a cut mode for TOP loudspeakers when used with d&b subwoofers; CPL, to compensate for the coupling effect between loudspeakers in close proximity to other loudspeakers or hard objects and HFA

mode, to attenuate the high frequencies of a loudspeaker to mimic the effect of far field listening. These devices offer extended, user-definable equalization and delay capabilities, eliminating the need for external processing devices in the signal chain. All d&b amplifiers integrate with the d&b Remote network to enable the remote control and management of systems from anywhere within a network. Further information is provided in the d&b Amplifier and Software brochure which is available for download at www.dbaudio.com.

Comparison of the d&b amplifiers

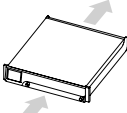
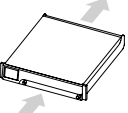
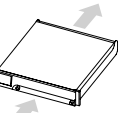
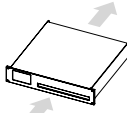
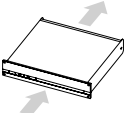
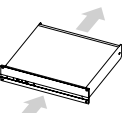
	D80	D40	D20	40D	30D	10D
User interface	Encoder/colour TFT touchscreen	Encoder/colour TFT touchscreen	Encoder/colour TFT touchscreen	Colour TFT touchscreen	LED indicators	LED indicators
Output channels	4	4	4	4	4	4
Input channels	4 x AES3 or 4 x analog or 2 x AES3 and 2 x analog	4 x AES3 or 4 x analog	4 x AES3 or 4 x analog or 2 x AES3 and 2 x analog	4 x AES3 and 4 x analog	4 x AES3 and 4 x analog	4 x AES3 and 4 x analog
Latency	0.3 msec	0.3 msec	0.3 msec	0.3 msec	0.3 msec	0.3 msec
User equalizers (per channel)	2 x 16-band	2 x 16-band	2 x 16-band	2 x 16-band	2 x 16-band	2 x 16-band
Delay	10 sec/3440 m	10 sec/3440 m	10 sec/3440 m	10 sec/3440 m	10 sec/3440 m	10 sec/3440 m
Maximum output power (THD+N < 0.5%, 12 dB crest factor)	4 x 2000 W into 8 ohms 4 x 4000 W into 4 ohms	4 x 2000 W into 8 ohms 4 x 2400 W into 4 ohms	4 x 800 W into 8 ohms 4 x 1600 W into 4 ohms	4 x 2000 W into 8 ohms 4 x 2400 W into 4 ohms	4 x 800 W into 8 ohms 4 x 1600 W into 4 ohms	4 x 350 W into 8 ohms 4 x 700 W into 4 ohms
Output routing	Dual Channel, Mix TOP/SUB 2-Way Active	Dual Channel, Mix TOP/SUB 2-Way Active	Dual Channel, Mix TOP/SUB 2-Way Active	Dual Channel, Mix TOP/SUB 2-Way Active	Dual Channel, Mix TOP/SUB 2-Way Active	Dual Channel, Mix TOP/SUB 2-Way Active
Output connectors	NL4 plus central NL8	NL4 plus central NL8	NL4 plus central NL8	Phoenix Euroblock	Phoenix Euroblock	Phoenix Euroblock
GPIO connector	No	No	No	Phoenix Euroblock 12 ports	Phoenix Euroblock 5 ports	Phoenix Euroblock 5 ports
Cable compensation	LoadMatch	LoadMatch	LoadMatch	LoadMatch	LoadMatch	LoadMatch
Power supply	Autosensing switched mode power supply with active PFC	Autosensing switched mode power supply with active PFC	Universal range switched mode power supply with active PFC	Autosensing switched mode power supply with active PFC	Universal range switched mode power supply with active PFC	Universal range switched mode power supply with active PFC
Mains voltage	100 - 127/208 - 240 V, 50 - 60 Hz	100 - 127/208 - 240 V, 50 - 60 Hz	100 - 240 V, 50 - 60 Hz	100 - 127/208 - 240 V, 50 - 60 Hz	100 - 240 V, 50 - 60 Hz	100 - 240 V, 50 - 60 Hz
Weight (kg/lb)	19/42	13.8/30.4	10.8/23.8	13.3/29.3	10.6/23.4	10.6/23.4
Dimensions	2 RU x 19" x 530 mm	2 RU x 19" x 465 mm	2 RU x 19" x 460 mm	2 RU x 19" x 465 mm	2 RU x 19" x 435 mm	2 RU x 19" x 435 mm
Remote	OCA via Ethernet/CAN	OCA/AES70 via Ethernet	OCA via Ethernet/CAN	OCA/AES70 via Ethernet	OCA via Ethernet/CAN	OCA via Ethernet/CAN
Airflow						

The controller setups and operation with d&b amplifiers

Arc and Line setups

The Arc mode is intended for line array loudspeakers when used in curved array sections. The Line mode is used for long throw array sections with three or more consecutive splay settings of 0°, 1° or 2°. Compared to the Arc mode, the mid/high range is reduced to compensate for the extended near field.

AP setup

In connection with ArrayProcessing (AP), the AP setup contains the AP data that are generated in the ArrayCalc simulation software. These are transferred to the applicable amplifiers via the d&b Remote network (OCA/AES70) using R1.

CUT mode

Set to CUT, the cabinet low frequency level is reduced and is configured for use with d&b active subwoofers.

HFC mode

Selecting the HFC (High Frequency Compensation) mode compensates for loss of high frequency energy due to absorption in air when loudspeakers are used to cover far field listening positions. HFC has two settings which should be used selectively, HFC1 for cabinets covering distances larger than 25 m (82 ft) and HFC2 for those covering distances larger than 50 m (164 ft). This can be used to achieve the correct sound balance between close and remote audience areas allowing all amplifiers driving the array to be fed from the same signal source.

HFA mode

In HFA mode (High Frequency Attenuation), the HF response of the system is rolled off. The HFA provides a natural, balanced frequency response when a unit is placed close to listeners in near field or delay use. HFA begins gradually at 1 kHz, dropping by approximately 3 dB at 10 kHz. This roll off mimics the decline in frequency response experienced when listening to a system from a distance in a typically reverberant room or auditorium.

CPL function

The CPL (Coupling) function compensates for coupling effects between the cabinets of an array. CPL begins gradually around 1 kHz, with the maximum attenuation below 100 Hz.

100 Hz mode

The 100 Hz mode limits the upper operating frequency of the subwoofer to 100 Hz, complementing top cabinets in full range mode.

CSA mode

CSA (Cardioid Subwoofer Array) mode enables the combination of three or multiples of three B6-SUB cabinets within an array producing exceptional low frequency directivity control. The amplifier channel for the centre subwoofer of the column, which is physically pointed to the rear, has CSA selected. The forward facing cabinets are driven with an amplifier channel set in the standard mode. For further information please refer to the d&b TI 330 Cardioid Subwoofer Array, which is available for download at www.dbaudio.com.

Recommended amplifiers for mobile applications

	Y7P	Y10P	B6	Y8	Y12	Y-SUB
D40	x	x	x	x	x	x
D80	x	x	x	x	x	x

Recommended amplifiers for installation applications

	Yi7P	Yi10P	Bi6	Yi8	Yi12	Yi-SUB
D80	x	x	x	x	x	x
30D	x	x	x	x	x	x
40D	x	x	x	x	x	x

Maximum loudspeakers per amplifier channel

	Y7P Yi7P	Y10P Yi10P	B6 Bi6	Y8 Yi8	Y12 Yi12	Y-SUB Yi-SUB
	2	2	2	2	2	2

Available controller settings

	Y7P Yi7P	Y10P Yi10P	B6 Bi6	Y8 Yi8	Y12 Yi12	Y-SUB Yi-SUB
Arc/Line				x	x	
AP				x	x	x
CUT	x	x		x	x	
HFC				x	x	
HFA	x	x				
CPL	x	x		x	x	

The Y-Series frequency responses

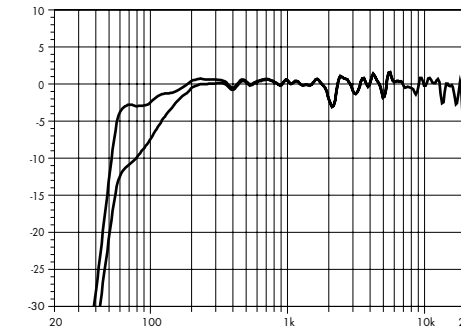

Y7P/Yi7P standard and CUT

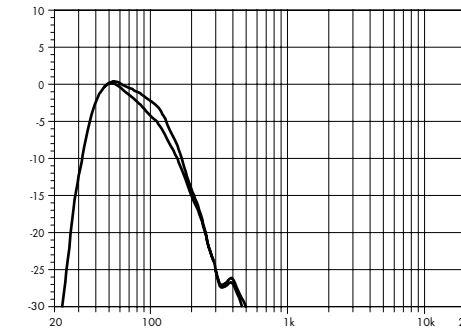

B6-SUB/Bi6-SUB standard and 100 Hz

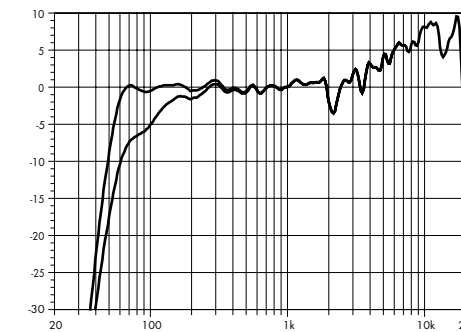

Y12/Yi12 standard and CUT (single cabinet)

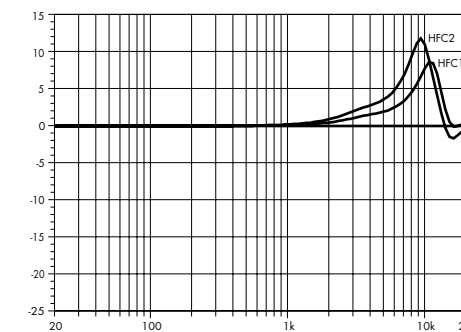

Correction of HFC*
*schematic diagram

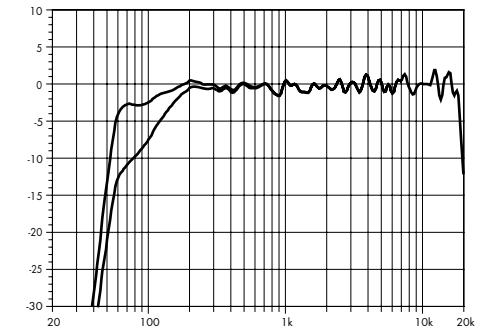

Y10P/Yi10P standard and CUT

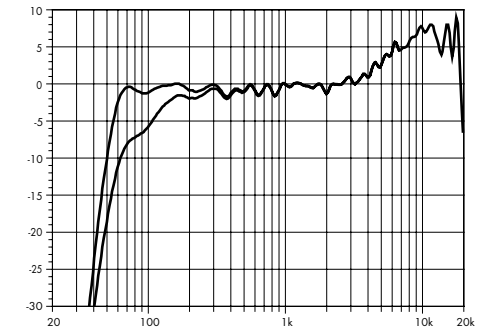

Y8/Yi8 standard and CUT (single cabinet)

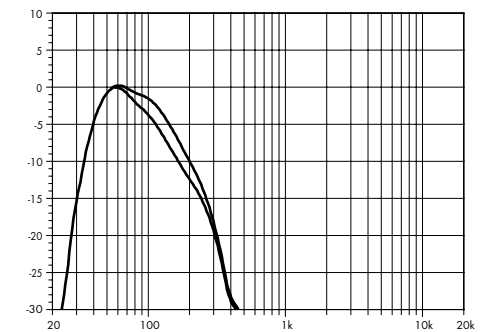

Y-SUB/Yi-SUB standard and 100 Hz

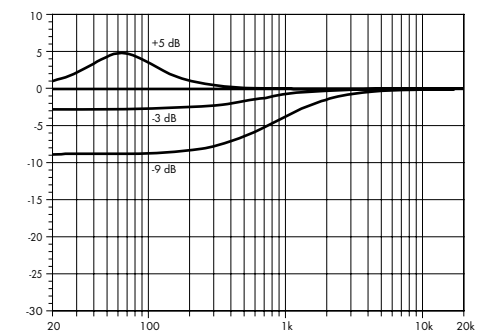

Correction of CPL*
*schematic diagram

The d&b amplifier output modes

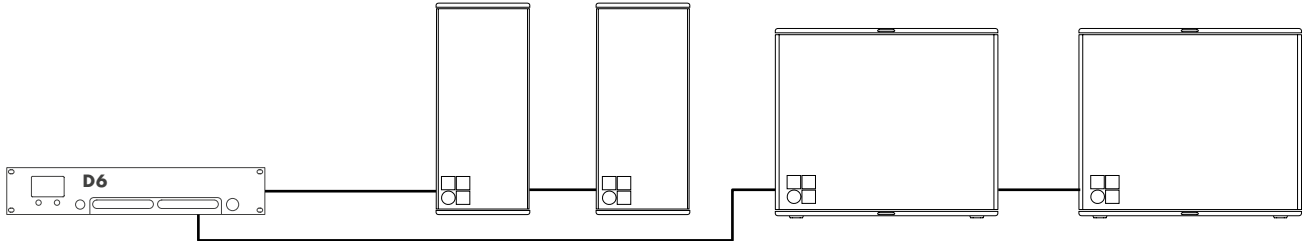

D6 amplifier in Dual Channel mode for Y7P, Y10P, Yi7P, Yi10P, Y8, Y12, Yi8, Yi12 as well as B6-SUB, Bi6-SUB, Y-SUB and Yi-SUB

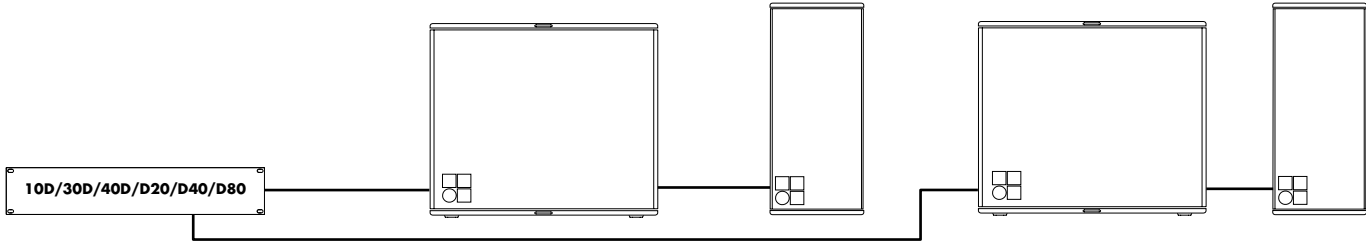

10D/30D/40D/D20/D40/D80 amplifier in Mix TOP/SUB mode for Y7P, Y10P, Yi7P, Yi10P, Y8, Y12, Yi8 or Yi12 and B6-SUB, Bi6-SUB, Y-SUB or Yi-SUB

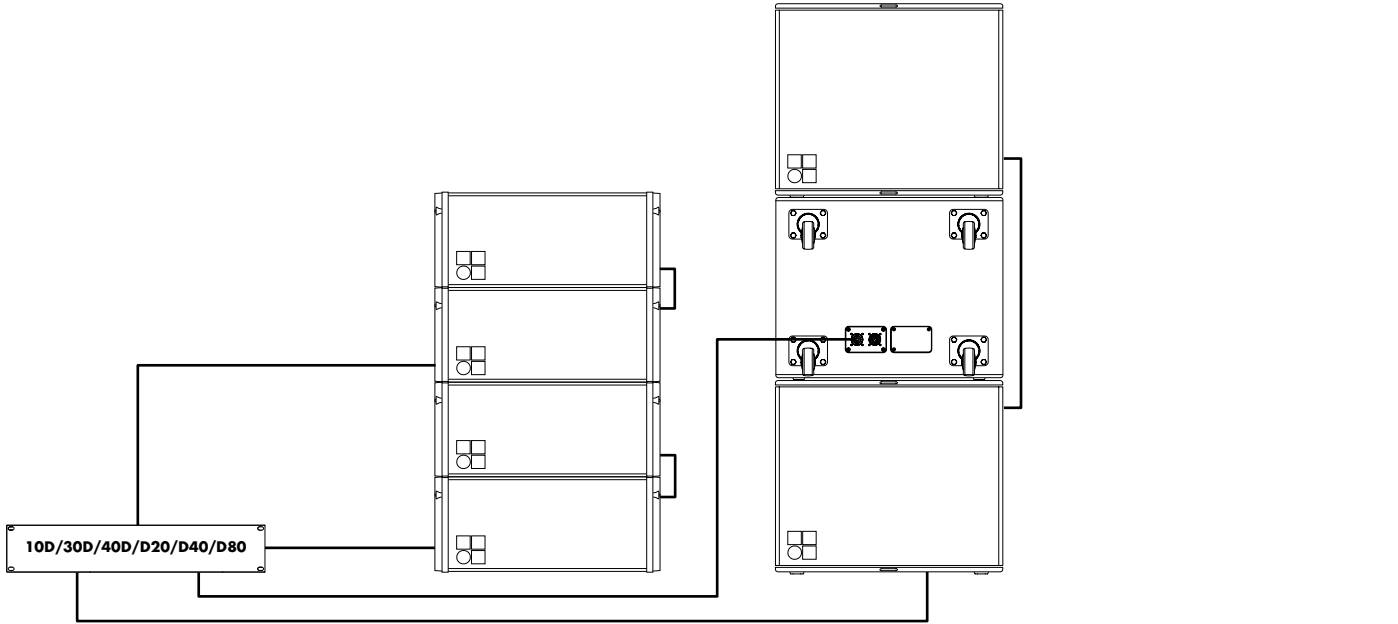

10D/30D/40D/D20/D40/D80 amplifier in Dual Channel mode for Y7P, Y10P, Yi7P, Yi10P, Y8, Y12, Yi8, Yi12 as well as B6-SUB, Bi6-SUB, Y-SUB and Yi-SUB (B6-SUB as CSA)

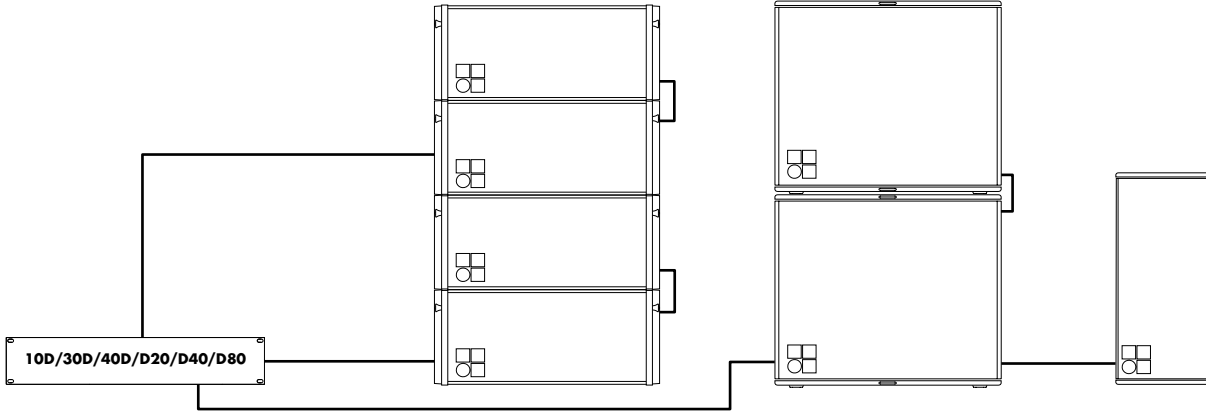

10D/30D/40D/D20/D40/D80 amplifier in a mixed configuration of Dual Channel and Mix TOP/SUB mode for Y7P, Y10P, Yi7P, Yi10P, Y8, Y12, Yi8 or Yi12 and B6-SUB, Bi6-SUB, Y-SUB or Yi-SUB

The DS10 and DS20 Audio network bridges

The DS100 Signal Engine

DS10 Audio network bridge

The DS10 Audio network bridge interfaces between Dante networks and AES3 digital audio signals, while also providing distribution of Ethernet control data. Positioned within the signal chain in front of the amplifiers, this 1 RU device expands the d&b system approach. Each unit can deliver up to sixteen Dante network channels via AES3 digital signal outputs. Additionally, four AES3 input channels provide access to the Dante audio network for applications such as a break-in from a Front of House console. The DS10 incorporates an integrated 5-port switch, offering a primary and redundant network for the Dante protocol, as well as advanced functions such as Multicast Filtering and VLAN modes. Using the DS10 Audio network bridge, audio signals and remote control data can be combined using a single Ethernet cable.



The DS10 Audio network bridge front view



The DS10 Audio network bridge rear view

DS20 Audio network bridge

The DS20 Audio network bridge supports the open standards-based Milan protocol rather than Dante. Milan (Media integrated local area networking) is a high level interoperability solution based on Audio Video Bridging (AVB) technology. The main advantages are deterministic behaviour (zero network congestion); improved reliability; optimum synchronization and hassle free network setup, as no special settings, such as QoS, need to be set within the switches to ensure delivery.



The DS20 Audio network bridge front view



The DS20 Audio network bridge rear view

DS100 Signal Engine

The d&b DS100 Signal Engine is the platform underneath the Soundscape, based on a specialized rack mount 3 RU audio processor with Audinate Dante networking. It provides a 64 x 64 audio matrix with level and delay adjustments at all cross points. Additional software modules provide dynamic source positioning and emulated acoustics functions. The DS100 is a versatile tool for use within complex audio systems to route and distribute multiple audio channels to numerous amplifiers driving loudspeaker positions and zones, show relay and break out rooms. The networking capabilities with a Dante enabled processor are significant, particularly for busy, multi-room complexes. The DS100 completely integrates with the overall d&b system approach, including loudspeakers, amplifiers, rigging, transport and networking accessories and the DS10 Audio network bridge. The complete system is designed and optimized in the d&b ArrayCalc simulation software, and controlled via the d&b R1 Remote control software.



The DS100 Signal Engine front view



The DS100 Signal Engine rear view

The Y-Series configuration examples

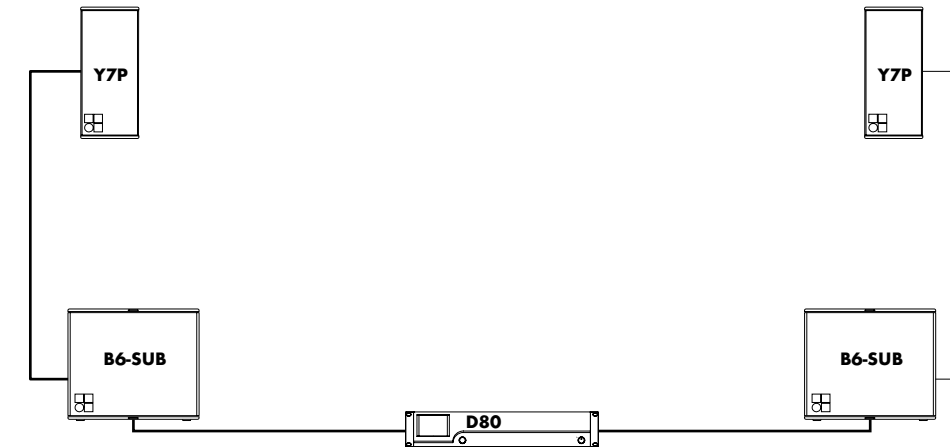

Y-Series L/R configuration comprising Y7P and B6-SUB with a D80 amplifier in Mix TOP/SUB mode¹

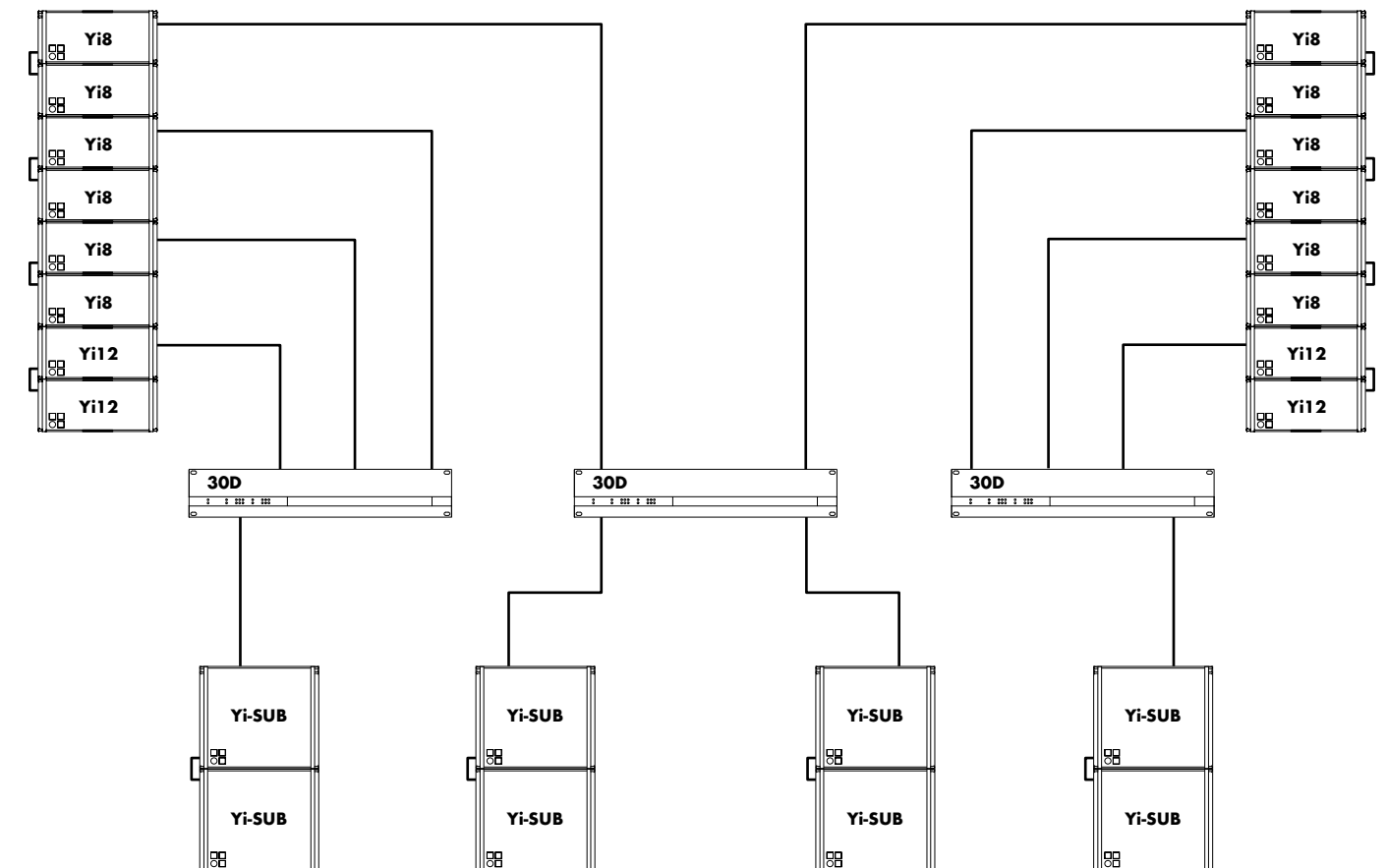

Yi line array in L/R configuration with flown Yi8/Yi12s and ground stacked Yi-SUBs with 30D amplifiers in Dual Channel mode¹

The Y-Series configuration examples

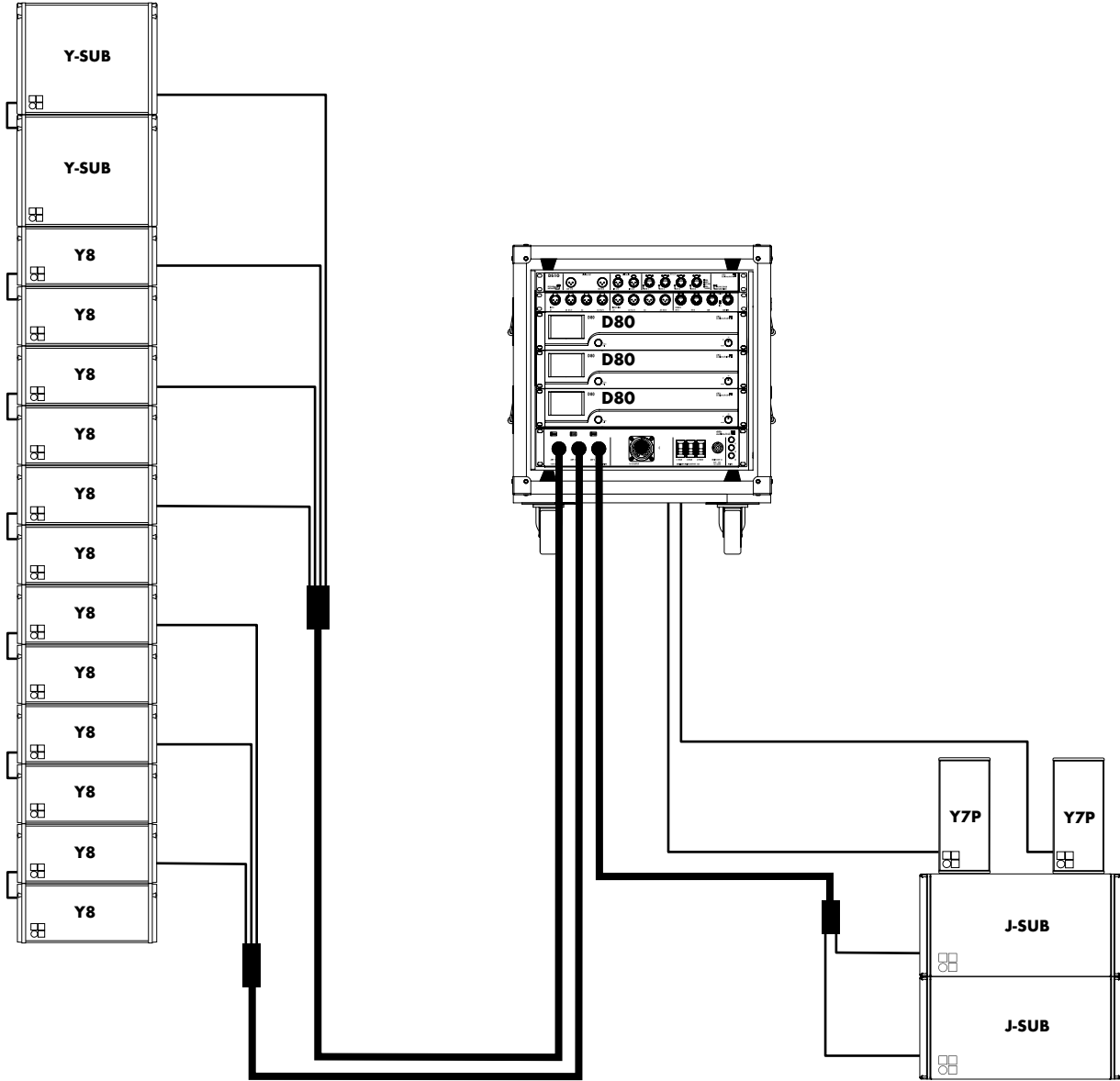

Y-Series configuration comprising Y8 and Y-SUB flown array with ground stacked J-Subs and Y7P as nearfill with D80 Touring rack¹

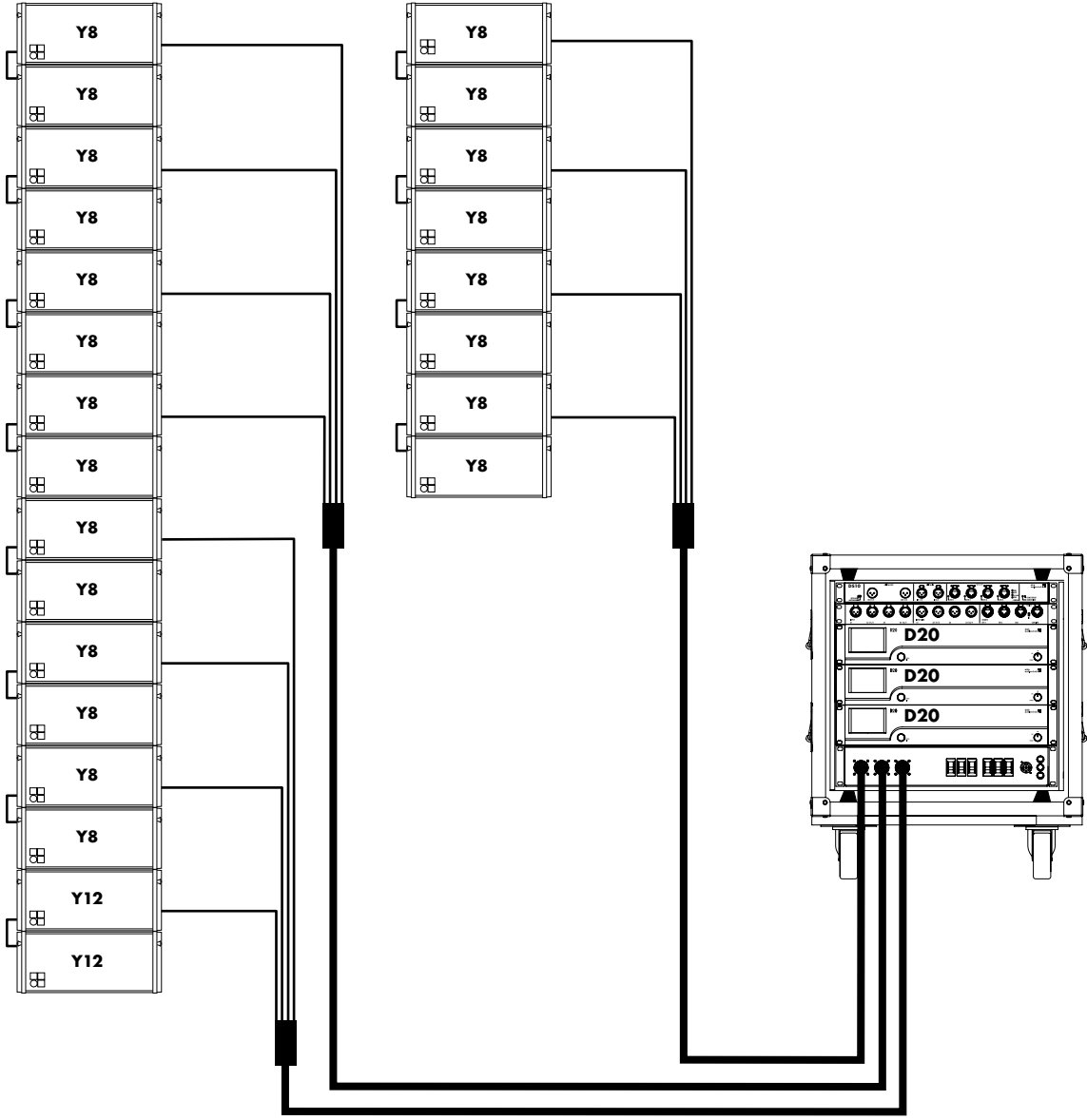

Y-Series configuration comprising Y8/Y12 mains and Y8 outfill arrays with D20 Touring rack¹

¹ These configurations are also valid for Yi loudspeakers

The Y-Series configuration examples with ArrayProcessing

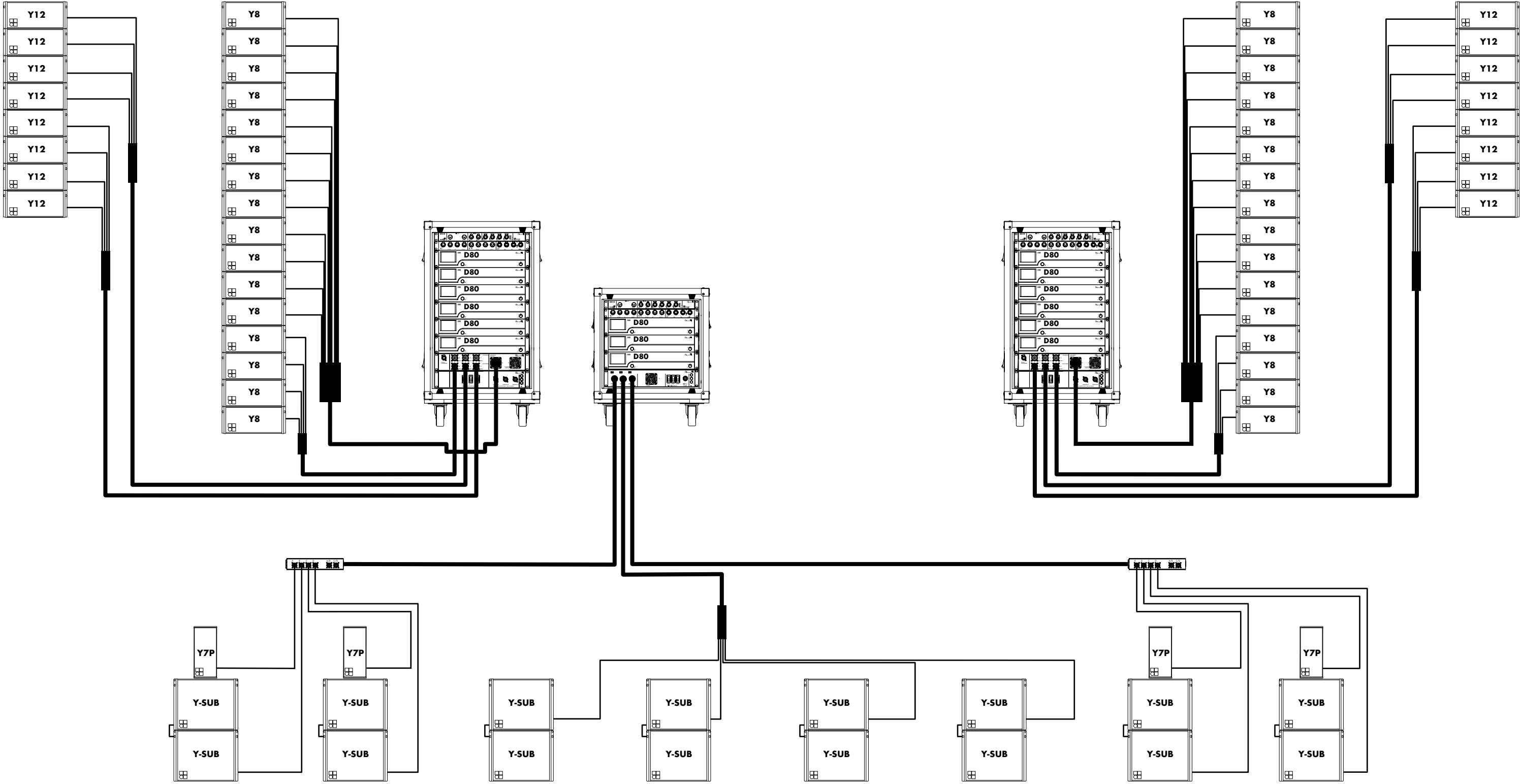

Y-Series configuration comprising Y8 mains and Y12 outfill arrays driven with ArrayProcessing along with ground stacked Y-SUBs and Y7P as nearfills with D80 Touring racks¹

¹ These configurations are also valid for Yi loudspeakers

The Y-Series cables and adapters MC8 / MC24

Amplifiers in Dual Channel mode

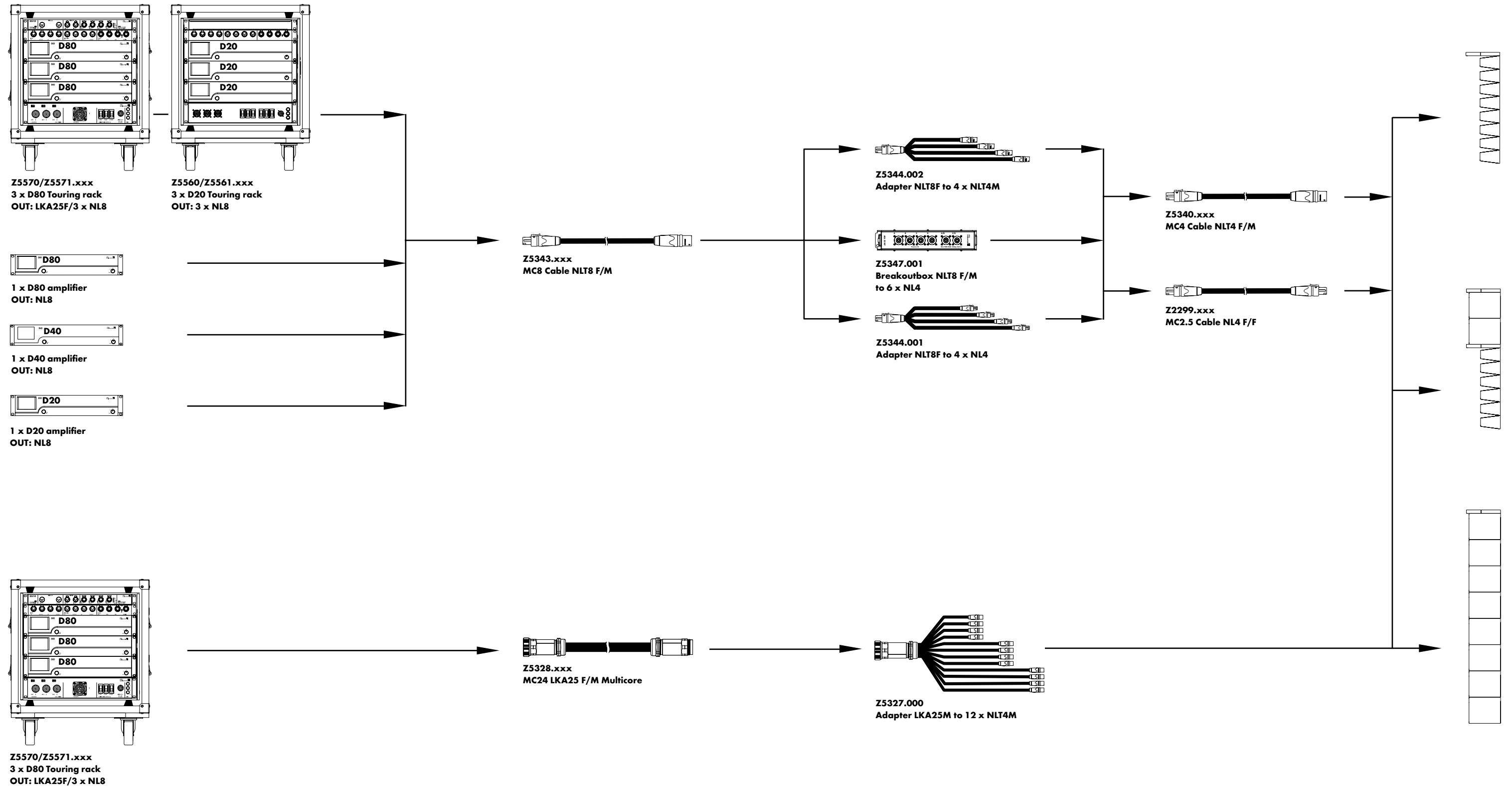

The Y-Series cables and adapters MC8 / MC24

Amplifiers in Dual Channel mode

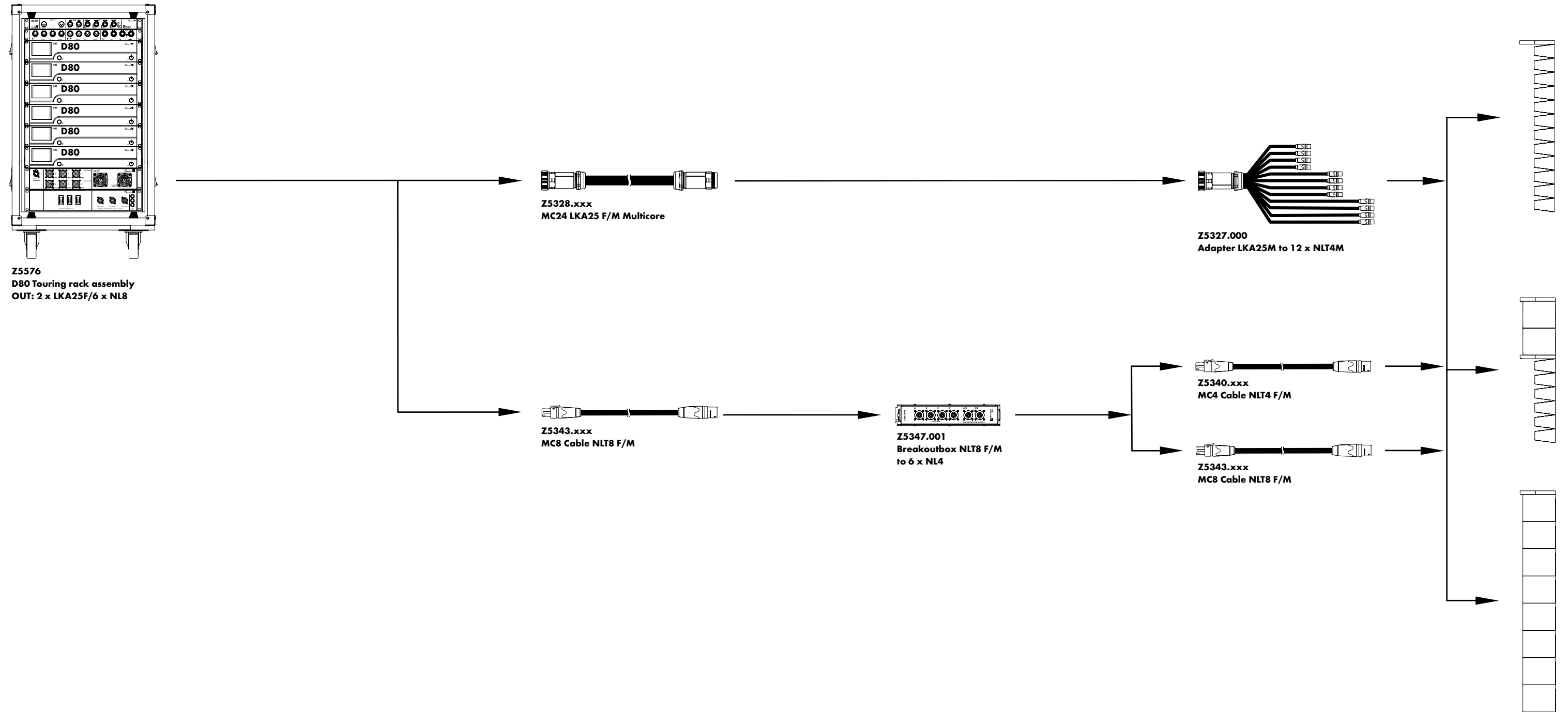

The Y-Series product overview

Y loudspeakers	Z0702.xxx Z0703.xxx Z0710.xxx Z0707.xxx Z0708.xxx Z0709.xxx	Y7P loudspeaker Y10P loudspeaker B6 subwoofer Y8 loudspeaker Y12 loudspeaker Y subwoofer	Z5392.000 Z5147.001 E6507.000	Y Safety chainset Rota clamp 1t Shackle
Loudspeaker connector options	Zxxxx.002 Zxxxx.001	NLT4 F/M connector NL4 connector	Remote network	Z6118.000 Z6124.000 R60 USB to CAN interface R70 Ethernet to CAN interface
Yi loudspeakers	Z0712.001 Z0713.001 Z0711.001 Z0717.001 Z0718.001 Z0719.001	Yi7P loudspeaker NL4 connector Yi10P loudspeaker NL4 connector Bi6 subwoofer NL4 connector Yi8 loudspeaker NL4 connector Yi12 loudspeaker NL4 connector Yi subwoofer NL4 connector	Processing and distribution	Z4010.000 Z4011.000 Z4100.000 DS10 Audio network bridge DS20 Audio network bridge DS100 Signal Engine
Loudspeaker cases	E7473.000 E7472.000 E7475.000	WR Weather Resistant option ¹ SC Special Colour option ² Touring case 2 x Y7P/Y10P Touring case 4 x Y8/Y12 Touring case 2 x Y Flying frame	Amplifiers	Z2710.xxx Z2850.xxx Z2750.xxx Z2830.xxx Z2770.xxx Z2760.xxx D80 Amplifier ⁴ D40 Amplifier ⁴ D20 Amplifier ⁴ 40D Amplifier ⁵ 30D Amplifier ⁵ 10D Amplifier ⁵
Loudspeaker carts	E7470.000 E7471.000	Touring cart 4 x Y8/Y12 Touring cart 8 x Y8/Y12	Amplifier rack assemblies	Z5560.xxx Z5561.xxx Z5570.xxx Z5571.xxx Z5576.xxx 3 x D20 Touring rack ⁶ 3 x D20 Touring rack (includes DS10) ⁶ 3 x D80 Touring rack ⁶ 3 x D80 Touring rack (includes DS10) ⁶ 6 x D80 Touring rack (includes DS10) ⁶
Lids	E7925.000 E7924.000	B6-SUB Transport lid Y-SUB Transport lid	Racks	E7480.000 E7468.000 E7483.000 D20 Touring rack 2 RU, 19" SD, shock mounted, handles D80 Touring rack 2 RU, 19" SD, shock mounted, handles DS100 Touring rack 3 RU, 19" SD, shock mounted, handles
YP accessories	Z5397.000 Z5398.000 Z5399.000 Z5389.000 Z5010.000 Z5012.500 Z5049.000 Z5013.000 Z5009.000 Z5024.000	YP Swivel bracket YP Horizontal bracket ³ YP Mounting bracket ³ Bi6-SUB Horizontal bracket ³ TV Spigot with fixing plate Pipe clamp for TV Spigot Flying pin 8mm M20 pole with winder Loudspeaker stand with winder Loudspeaker stand adapter	Cables and adapters	Z5339.000 Z5343.xxx Z5345.001 Z5344.002 Z5344.001 Z5347.001 Z5340.xxx Z5328.xxx Z5327.000 Z2299.xxx Z5763.000 Multichannel extension cable MC8 Cable NLT8 F/M Adapter 4 x NL4 to NLT8M Adapter NLT8F to 4 x NLT4M Adapter NLT8F to 4 x NL4 Breakoutbox NLT8 F/M to 6 x NL4 MC4 Cable NLT4 F/M MC24 LKA 25 F/M Multicore Adapter LKA25M to 12 x NLT4M MC2.5 Cable NL4 F/F WR 5,5m cable 2x2.5mm ^{2,7}
Y accessories	Z5390.000 Z5394.000 Z5393.000 Z5393.001 Z5396.000 Z5391.000	Y Flying frame ³ Y Flying adapter ³ Yi Mounting frame top ³ Yi Mounting frame bottom ³ Y Base plate Y Hoist connector chain		

¹ WR only for Yi loudspeakers, on request

² SC only for Yi loudspeakers

³ SC on request

⁴ The complete list of mobile amplifier versions is available in the d&b D Amplifier and Software brochure

⁵ The complete list of installation amplifier versions is available in the d&b xD Installation Amplifier and Software brochure

⁶ Further information is available in the d&b D Amplifier and Software brochure

⁷ Other lengths on request

